

CITIZEN

Command Reference

LINE THERMAL PRINTER

MODEL **BD2-2220**

Rev. 0.00 Issued on 2006/8/4

CITIZEN SYSTEMS JAPAN CO.,LTD.

REVISION

Rev No.	Date	Comment
0.00	2006/08/04	Newly issued

TABLE OF CONTENTS

1. OUTLINE	5
1.1 Operation Mode	5
1.2 Character Set	5
1.3 Control Commands	5
1.3.1 Control Command Details	5
1.3.2 How to Send Control Commands	5
2. CONTROL COMMANDS	6
2.1 ESC/POS Command List	6
2.1.1 Description of Items	9
2.2 Command Details	10
2.2.1 Print Control Commands	10
LF (Printing and paper feed).....	10
CR (Back to printing).....	11
FF (Printing in PAGE MODE and returning to STANDARD MODE)	12
ESC FF (Printing data in PAGE MODE).....	13
ESC J n (Printing and feeding paper in minimum pitch)	13
ESC d n (Printing and feeding the paper by “n” lines)	14
2.2.2 Print Character Commands	15
CAN (Canceling print data in PAGE MODE).....	15
ESC SP n (Setting the right spacing of the character)	16
ESC ! n (Collectively specifying the printing mode)	17
ESC % n (Specifying/canceling download character set).....	19
ESC & s n m [a [p] s x a] m-n+1 (Defining the download characters)	20
ESC - n (Specifying/canceling underline)	21
ESC ? n (Deleting download characters)	22
ESC E n (Specifying/canceling emphasis printing)	23
ESC G n (Specifying/canceling double strike printing).....	24
ESC M n (Selection of character fonts)	25
ESC R n (Selecting the international character set).....	25
ESC V n (Specifying/canceling 90°-right-turned characters).....	26
ESC t n (Selecting the character code table).....	27
ESC { n (Specifying/canceling the inverted characters)	28
GS ! n (Specifying the character size).....	29
GS B n (Specifying/canceling the black/white inverted printing).....	30
GS b n (Specifying/canceling the smoothing).....	31

2.2.3 Print Position Commands	32
HT (Horizontal tab).....	32
ESC \$ n1 n2 (Specifying the absolute positions)	33
ESC D [n] k NULL (Setting horizontal tab position)	34
ESC T n (Selecting the character printing direction in PAGE MODE).....	35
ESC W xL xH yL yH dxL dxH dyL dyH (Defining the print area in PAGE MODE)	36
ESC \ nL nH (Specifying the relative position)	37
ESC a n (Aligning the characters)	38
GS \$ nL nH (Specifying the absolute vertical position of characters in PAGE MODE).....	39
GS L nL nH (Setting the left margin)	40
GS W nL nH (Setting the print area width)	41
GS \ nL nH (Specifying the relative vertical position of a character in PAGE MODE).....	43
2.2.4 Line Feed Span Commands	44
ESC 2 (Specifying 1/6-inch line feed rate)	44
ESC 3 n (Setting line feed rate of minimum pitch)	45
2.2.5 Bit Image Commands	46
ESC * m n1 n2 [d] k (Specifying the bit image mode)	46
GS * n1 n2 [d] n1 x n2 x 8 (Defining the download bit image).....	48
GS / m (Printing the downloaded bit image).....	50
GS v 0 m xL xH yL yH d1...dk (Printing of raster bit image)	51
2.2.6 Status Commands	53
DLE EOT n (Sending status in real-time)	53
GS a n (Enabling/disabling ASB (Automatic Status Back))	56
GS r n (Sending status)	59
2.2.7 Paper Detecting Commands	60
ESC c 3 n (Selecting the Paper Sensor valid for Paper-end signal output)	60
ESC c 4 n (Selecting the Paper Near-end Sensor valid for print stop).....	61
2.2.8 Panel Switch Commands	62
ESC c 5 n (Enabling/disabling the LF-SW signal)	62
2.2.9 Macro Commands	63
GS : (Starting/ending macro definition)	63
GS ^ n1 n2 n3 (Executing the macro)	64
2.2.10 Cutter Commands	65
ESC i (Full cut)	65
ESC m (Partial cut)	66
GS V m (1) (Cutting the paper)	67
GS V m n (2) (Cutting the paper)	67

2.2.11 Bar Code Commands	68
GS H n (Selecting of printing position of HRI characters)	68
GS f n (Selecting the font of HRI characters)	70
GS h n (Specifying the height of the bar code)	71
GS k m [d1 dk] NULL (1) (Printing the bar code)	72
GS k m n [d1 dn] (2) (Printing the bar code)	72
GS w n (Specifying the horizontal size (magnification) of bar code)	78
2.2.12 Commands for Non-volatile Memory	79
F S p n m (Printing the download NV bit images)	79
F S q n [xL xH yL yH d1...dk] 1... [xL xH yL yH d1...dk] n (Defining the download NV bit image) ..	80
2.2.13 Printer Function Setting Commands	82
GS (E pL pH fn [...] (Printer function setting command)	82
fn = 1: Function 1 Transferring to Printer Function Setting Mode	83
fn = 2: Function 2 End of Printer Function Setting Mode	84
fn = 3: Function 3 Setting Memory Switch Value	85
fn = 4: Function 4 Sending the Set Memory Switch Value	87
fn = 5: Function 5 Setting Customized Value	88
fn = 6: Function 6 Sending the Set Customized Value	90
fn = 7: Function 7 Copying User-defined Page	92
fn = 8: Function 8 Defining Data by the Column Format to Character Code Page of Work Area	93
fn = 9: Function 9 Defining Data in the Raster Format to the Character Code Page of Work Area ..	94
fn = 10: Function 10 Erasing Data of Character Code Page Data in Work Area	95
fn = 11: Function 11 Setting Communication Conditions of Serial Interface	96
fn = 12: Function 12 Sending the Set Communication Conditions of Serial Interface	97
fn = 255: Function 255 Setting All Contents Set by Printer Function Setting Mode to the State at Shipment	98
GS (K pL pH fn m (Customizing the printer)	99
fn = 49: Function 49 Setting Printing Density	100
fn = 50: Function 50 Setting Printing Speed	101
GS (M pL pH fn m (Selecting print control method)	102
fn = 1, 49: Function 1 : Copies the set value stored in work area to the storage area	103
fn = 2, 50: Function 2 : Copies the set value stored in storage area to the work area	103
fn = 3, 51: Function 3: Specifies the auto loading function of the set value at initialization to be valid or invalid	104
2.2.14 Other Commands	105
DLE ENQ n (Real-time request to printer)	105
DLE DC4 fn d1...d7 (Specification of fn = 8) (Buffer clear)	106
ESC = n (Data input control)	107
ESC @ (Initializing the printer)	108
ESC L (Selecting PAGE MODE)	109
ESC S (Selecting STANDARD MODE)	110
GS (A pL pH n m (Execution of test printing)	111
GS I n (Sending the printer ID)	112
GS P x y (Specifying the basic calculation pitch)	114

3. CHARACTER CODE TABLE	115
3.1 Code Page	115
3.1.1 Codepage 00H to 7FH & PC437 (USA, Europe Standard).....	115
3.1.2 Codepage 00H to 7FH & Katakana	116
3.1.3 Codepage 00H to 7FH & PC850 (Multilingual)	117
3.1.4 Codepage 00H to 7FH & PC860 (Portuguese).....	118
3.1.5 Codepage 00H to 7FH & PC863 (Canadian-French)	119
3.1.6 Codepage 00H to 7FH & PC865 (Nordic)	120
3.1.7 Codepage 00H to 7FH & PC852 (Eastern Europe)	121
3.1.8 Codepage 00H to 7FH & PC866 (Russian).....	122
3.1.9 Codepage 00H to 7FH & PC857 (Turkish).....	123
3.1.10 Codepage 00H to 7FH & PC864 (Arabic)	124
3.1.11 Codepage 00H to 7FH & WPC1252.....	125
3.1.12 Codepage 00H to 7FH & Thai Code 18.....	126
3.2 International Character Code Table	127
4. APPENDIX.....	128
4.1 Explanation on PAGE MODE.....	128
4.1.1 Overview	128
4.1.2 Values Set by Each Command in STANDARD MODE and PAGE MODE.....	128
4.1.3 Mapping of Print Data in the Print Area	129
4.1.4 Example of Using PAGE MODE.....	130
4.2 Bidirectional Parallel Interface.....	133
4.2.1 Parallel Interface Communication Mode	133
4.2.2 Interfacing Phases	133
4.2.3 Negotiation	134
4.3 Identification of Send Status	139
4.4 Memory Switch	140
4.4.1 Memory Switches.....	140
4.4.2 Details of Memory Switches.....	141
(1) MSW1	141
(2) MSW2	144
(3) MSW3	145

1. OUTLINE

1.1 Operation Mode

CT-S280 has ESC/POSTM as control commands.

1.2 Character Set

All print data sent from the host computer to the printer are automatically converted to one-byte alphanumeric or katakana characters (ANK) or two-byte Kanji corresponding to the characters and symbols.

NOTE: For the contents of character set, refer to Character Code Table of this document.

1.3 Control Commands

1.3.1 Control Command Details

Control Commands are used for controlling the operations of the printer such as starting/stopping of printing, line feeding, paper feeding, etc. They control all functions related to printing, such as type of characters, enlargement of characters or setting of format.

1.3.2 How to Send Control Commands

Some methods are available for sending Control Commands from the host computer to the printer. Here, a method of sending by BASIC programming is explained.

Example 1

Let's print a character string "CITIZEN" in enlarged (double-height, double-width) and in normal format.

Program coding

The Control Command shows that the command name for setting the size of a character is GS !. Let's make a program using this code. An example is shown below.

Program List

```
10 A$="CITIZEN"  
20 LPRINT CHR$(&H1D);"!"; CHR$(&H33);  
30 LPRINT A$;  
40 LPRINT CHR$(&HA); CHR$(&HA);  
50 LPRINT CHR$(&H1D);"!"; CHR$(&H00);  
60 LPRINT A$;  
70 END
```

Print Result

```
CITIZEN  
  
CITIZEN
```

In lines 20 and 50, setting and canceling of enlarging a character is sent. As a result, lines 30 and 60 print the same character string but line 30 prints enlarged characters and line 60 cancels the enlargement and prints in normal format.

* In this document, sample programs are in BASIC. For details of BASIC programming, refer to the manual for BASIC.

2. CONTROL COMMANDS

2.1 ESC/POS Command List

Print Control Commands

Command	Function	Mode	GS P
LF	Printing and paper feed	S.P.	
CR	Back to printing	S.P.	
FF	Printing in PAGE MODE and returning to STANDARD MODE (at the selection of PAGE MODE)	P	
ESC FF	Printing data in PAGE MODE	P	
ESC J	Printing and feeding paper in minimum pitch	S.P.	O
ESC d	Printing and feeding the paper by “n” lines	S.P.	

Print Character Commands

Commands	Function	Mode	GS P
CAN	Canceling print data in PAGE MODE	P	
ESC SP	Setting the right spacing of the character	S.P.	O
ESC !	Collectively specifying the printing mode	S.P.	
ESC %	Specifying/canceling download character set	S.P.	
ESC &	Defining the download characters	S.P.	
ESC –	Specifying/canceling underline	S.P.	
ESC ?	Deleting download characters	S.P.	
ESC E	Specifying/canceling emphasis printing	S.P.	
ESC G	Specifying/canceling double strike printing	S.P.	
ESC M	Selection of character fonts	S.P.	
ESC R	Selecting the international character set	S.P.	
ESC V	Specifying/canceling 90°-right-turned characters	S	
ESC t	Selecting the character code table	S.P.	
ESC {	Specifying/canceling the inverted characters	S	
GS !	Specifying the character size	S.P.	
GS B	Specifying/canceling the black/white inverted printing	S.P.	
GS b	Specifying/canceling the smoothing	S.P.	

Print Position Commands

Commands	Function	Mode	GS P
HT	Horizontal tab	S.P.	
ESC \$	Specifying the absolute positions	S.P.	0
ESC D	Setting horizontal tab position	S.P.	
ESC T	Selecting the character printing direction in PAGE MODE	P	
ESC W	Defining the print area in PAGE MODE	P	0
ESC \	Specifying the relative position	S.P.	0
ESC a	Aligning the characters	S	
GS \$	Specifying the absolute vertical position of characters in PAGE MODE	P	0
GS L	Setting the left margin	S	0
GS W	Setting the print area width	S.P.	0
GS \	Specifying the relative vertical position of a character in PAGE MODE	S.P.	0

Line Feed Span Commands

Commands	Function	Mode	GS P
ESC 2	Specifying 1/6-inch line feed rate	S.P.	
ESC 3	Setting line feed rate of minimum pitch	S.P.	0

Bit Image Commands

Commands	Function	Mode	GS P
ESC *	Specifying the bit image mode	S.P.	
GS *	Defining the download bit image	S.P.	
GS /	Printing the downloaded bit image	S.P.	
GS v0	Printing of raster bit image	S	

Status Commands

Commands	Function	Mode	GS P
DLE EOT.	Sending status in real-time	S.P.	
GS a	Enabling/disabling ASB (Automatic Status Back)	S.P.	
GS r	Sending status	S.P.	

Paper Detecting Commands

Commands	Function	Mode	GS P
ESC c3	Selecting the Paper Sensor valid for Paper-end signal output	S.P.	
ESC c4	Selecting the Paper Near-end Sensor valid for print stop	S.P.	

Panel Switch Commands

Commands	Function	Mode	GS P
ESC c5	Enabling/disabling the LF-SW signal	S.P.	

Macro Commands

Commands	Function	Mode	GS P
GS :	Starting/ending macro definition	S.P.	
GS ^	Executing the macro	S.P.	

Cutter Commands

Command	Function	MODE	GS P
ESC i	Full cut		
ESC m	Partial cut		
GS V	Cutting the paper	S.P.	o

Bar Code Commands

Commands	Function	Mode	GS P
GS H	Selecting of printing position of HRI characters	S.P.	
GS f	Selecting the font of HRI characters	S.P.	
GS h	Specifying the height of the bar code	S.P.	
GS k	Printing the bar code	S.P.	
GS w	Specifying the horizontal size (magnification) of bar code	S.P.	

Commands for Non-volatile Memory

Commands	Function	Mode	GS P
FS p	Printing the download NV bit images	S	
FS q	Defining the download NV bit image	S	

Printer Function Setting Commands

Commands	Function	Mode	GS P
GS (E	Printer function setting command	S	
GS (M	Customizing the printer	S	
GS (K	Selecting print control method	S	

Other Commands

Commands	Function	Mode	GS P
DLE ENQ	Real-time request to printer	S.P.	
DLE DC4	Buffer clear	S.P.	
ESC =	Data input control	S.P.	
ESC @	Initializing the printer	S.P.	
ESC L	Selecting PAGE MODE	S	
ESC S	Selecting STANDARD MODE	P	
GS (A	Execution of test printing	S	
GS I	Sending the printer ID	S.P.	
GS P	Specifying the basic calculation pitch	S.P.	

In the Mode column: S = STANDARD MODE, P = PAGE MODE
O = shows the command affected by GS P.

2.1.1 Description of Items

XXXX

[Function]	The name of a command.
[Code]	The string of codes comprising the command is represented by < >H for hexadecimal numbers, < >B for binary numbers, and < > for decimal numbers, [] k denotes the number of repetition of “k” times.
[Range]	Indicates the values (setting range) of arguments of the command. Note: If values outside the defined domain specified with control codes are used, malfunctions could possibly occur, so be sure to use the values within the defined domain.
[Outline]	Describes the functions of the command.
[Caution]	Describes important points and cautionary notes, as required.
[Default]	Initial values for the command if it has arguments.
[See Also]	Describes commands related to the command when it is used.
[Sample Program]	Describes examples of coding on Quick-Basic. * Examples are only for reference. They may vary depending on language and version. For details, please refer to a manual in your language.
[Print Results]	Describes the print results obtained by executing the above programs. However, the print results shown are different in scale from actual print results.

2.2 Command Details

2.2.1 Print Control Commands

LF

[Function]	Printing and paper feed
[Code]	<0A>H
[Outline]	Prints data inside the print buffer and feeds paper based on the line feed amount having been set.
[Caution]	After this command is executed, the beginning of the line is taken as the start position for the next point.
[See Also]	ESC 2, ESC 3
[Sample Program]	<pre>LPRINT "AAA"; CHR\$(&HA); LPRINT "BBB"; CHR\$(&HA); CHR\$(&HA); LPRINT "CCC"; CHR\$(&HA);</pre>
[Print Results]	<pre>AAA ←——. Print and line feed BBB ←—— Print and line feed ←—— Line feed only CCC ←—— Print and line feed</pre>

CR

[Function] Back to printing

[Code] <0D>H

[Outline] (1) When memory switch 1-5 is OFF:
This command is ignored.
(2) When memory switch 1-5 is ON:
The same operation as LF is executed.

[See Also] LF

[Sample Program]

```
LPRINT "AAA"; CHR$(&HD);  
LPRINT "BBB"; CHR$(&HD);  
LPRINT CHR$(&HD);  
LPRINT "CCC"; CHR$(&HD);
```

[Print Results]

In case of (2)
AAA ← Print and line feed
BBB ← Print and line feed
← Line feed only
CCC ← Print and line feed

FF

[Function]	Printing in PAGE MODE and returning to STANDARD MODE (at the selection of PAGE MODE)
[Code]	<0C>H
[Outline]	Executes a batch printout of the data mapped in the entire print area, and then returns to STANDARD MODE.
[Caution]	<ul style="list-style-type: none">• All mapped data is erased after printout.• The print area set up by ESC W is initialized.• After this command is executed, the beginning of the line is taken as the start position for the next print.• This command is only effective when the PAGE MODE is selected.
[See Also]	Appendix 4.1.4 "Example of Using PAGE MODE" ESC FF, ESC L, ESC S

ESC FF

[Function]	Printing data in PAGE MODE
[Code]	<1B>H<0C>H
[Outline]	Executes a batch printout of the data mapped in the entire print area in PAGE MODE.
[Caution]	<ul style="list-style-type: none">• This command is only effective when PAGE MODE is selected.• Mapped data, as well as the ESC T and ESC W settings, and the character mapping position are held even after printing.
[See Also]	Appendix 4.1 “Explanation on PAGE MODE” FF, ESC L, ESC S

ESC J n

[Function]	Printing and feeding paper in minimum pitch
[Code]	<1B>H<4A>H<n>
[Range]	0≤n≤255
[Outline]	Prints the data held in the print buffer and feeds paper by [n x basic calculation pitch] inches.
[Caution]	<ul style="list-style-type: none">• After this command is executed, the beginning of the line is taken as the start position for the next print.• The line feed width can be set separately for the STANDARD and PAGE MODES.• This command does not affect the line feed width defined by ESC 2 or ESC 3.• The basic calculation pitch is set by GS P.• Fractions resulting from calculation are corrected with the minimum pitch of the mechanism, and the remainder is omitted.• In STANDARD MODE, this command uses the vertical (paper feed direction) basic calculation pitch (y).• In PAGE MODE, this command acts differently depending on the start point:<ol style="list-style-type: none">(1) If the start point specified by ESC T is top left or bottom right, the command uses the vertical (Paper feed direction) basic calculation pitch (y).(2) If the start point specified by ESC T is top right or bottom left, the command uses the horizontal (Perpendicular to the paper feed direction) basic calculation pitch (x).The maximum settable line feed width is 1016 mm (40 inches). A setting greater than this maximum is trimmed to the maximum.
[Default]	The initial value is not defined.
[Sample Program]	Refer to Sample Program and Print Results for ESC 2.

ESC d n

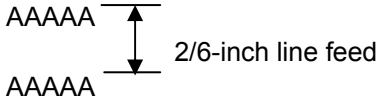
[Function]	Printing and feeding the paper by “n” lines
[Code]	<1B>H<64>H<n>
[Range]	0≤n≤255
[Outline]	Prints data in the print buffer and feeds paper by “n” lines. Specified lines do not remain.
[Caution]	<ul style="list-style-type: none">• After this command is executed, the beginning of the line is taken as the start position for the next print.• If [n x line feed width] exceeds approximately 1016 mm, this command feeds paper by approximately 1016 mm (40 inches).
[Default]	The initial value is not defined.
[Sample Program]	<pre>LPRINT "AAAAA"; LPRINT CHR\$(&H1B);"d"; CHR\$(2); LPRINT "AAAAA"; CHR\$(&HA);</pre>
[Print Results]	 <p>AAAAA ↑ ↓ AAAAA 2/6-inch line feed</p>

2.2.2 Print Character Commands

CAN

[Function]	Canceling print data in PAGE MODE
[Code]	<18>H
[Outline]	Erases all data contained in the currently effective print area in PAGE MODE.
[Caution]	<ul style="list-style-type: none">• This command is only effective when PAGE MODE is selected.• If the previously established print area overlaps the currently effective print area, the overlapped data in the previously established area will be erased.
[See Also]	Appendix 4.1 "Explanation on PAGE MODE" ESC L, ESC W

ESC SP n

- [Function]** Setting the right spacing of the character
- [Code]** <1B>H<20>H<n>
- [Range]** 0≤n≤255
- [Outline]** Sets the right spacing of character to [n x basic calculation pitch] inches.
- [Caution]** • If the horizontal magnification of character is 2 or more, the right spacing increases with the magnification.
• Does not affect Kanji.
• The right spacing can be set separately for the STANDARD and PAGE MODES.
• The basic calculation pitch is set by GS P. Once defined, the right spacing is not changed if the basic calculation pitch is changed by GS P.
• Fractions resulting from calculation are corrected with the minimum pitch of the mechanism, and the remainder is omitted.
• In STANDARD MODE, this command uses the horizontal basic calculation pitch (x).
• In PAGE MODE, the basic calculation pitch used by this command depends on the start point:
 (1) If the start point specified by ESC T is top left or bottom right, the command uses the horizontal basic calculation pitch (x).
 (2) If the start point specified by ESC T is top right or bottom left, the command uses the vertical basic calculation pitch (y).
• The maximum right spacing is capable of approximately 31.906 mm (255/203 inches). A setting greater than this maximum is trimmed to the maximum.

[Default] n = 0

[See Also] GS P

[Sample Program]

```
LPRINT CHR$(&H1B);" "; CHR$(0);  
LPRINT "AAAAA"; CHR$(&HA);  
LPRINT CHR$(&H1B);" "; CHR$(1);  
LPRINT "AAAAA"; CHR$(&HA);  
LPRINT CHR$(&H1B);" "; CHR$(12);  
LPRINT "AAAAA"; CHR$(&HA);
```

[Print Results]

```
AAAAA ← 0-dot space  
A A A A A ← 1-dot space  
A A A A A ← 12-dots space
```

ESC ! n

[Function] Collectively specifying the printing mode

[Code] <1B>H<21>H<n>

[Range] 0≤n≤255

[Outline] Printing mode is assigned.

Bit	Function	Value	
		0	1
0	Character Font	Font A (12 x 24)	Font B (9 x 24)
1	Undefined	—	—
2	Undefined	—	—
3	Emphasis	Canceled	Specified
4	Double height	Canceled	Specified
5	Double width	Canceled	Specified
6	Undefined	—	—
7	Underline	Canceled	Specified

- [Caution]**
- With double height and double width being specified simultaneously, quadruple characters are created.
 - An underline is attached to the full character width, which, however, is not attached to the part having been skipped by the horizontal tab (HT). Neither is it attached to 90°-right-turned characters.
 - The underline width is as specified by the ESC – command. (The default setting is 1 dot width.)
 - Setting by this command is invalid for Kanji except setting and canceling of enhanced printing.
 - In case characters with different vertical magnification ratios coexist on the same line, they are printed on the same base line.
 - ESC E, ESC M, ESC –, and GS ! can individually set or cancel the mode but the command processed last is valid.
 - Setting or canceling of enhanced 3rd bit is valid for alphanumeric and kana and kanji. Other print mode is valid only for alphanumeric and kana characters.
 - Setting MSW3-7 to ON allows the relation between length and width for a character to be reversed when specifying 90°-right-turned characters.

[Default] n = 0

[See Also] ESC E, ESC –, GS !

[Sample Program]

```
LPRINT CHR$(&H1B);"!"; CHR$(&H00);"H";  
LPRINT CHR$(&H1B);"!"; CHR$(&H01);"H";  
LPRINT CHR$(&H1B);"!"; CHR$(&H08);"H";  
LPRINT CHR$(&H1B);"!"; CHR$(&H10);"H";  
LPRINT CHR$(&H1B);"!"; CHR$(&H20);"H";  
LPRINT CHR$(&H1B);"!"; CHR$(&H80);"H";  
LPRINT CHR$(&H1B);"!"; CHR$(&HB9);"H";  
LPRINT CHR$(&HA);
```

[Print Results]

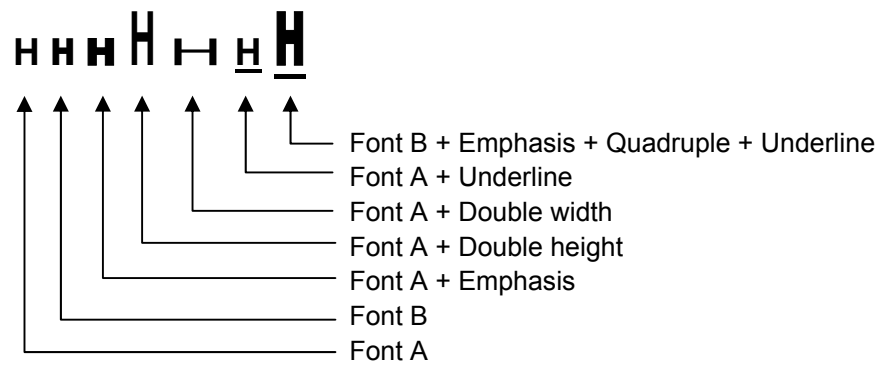

ESC % n

[Function] Specifying/canceling download character set

[Code] <1B>H<25>H<n>

[Range] 0≤n≤255

[Outline] Specifying/canceling download characters.
 • “n” is valid only for the lowest bit (n0).
 • Control by the lowest bit (n0) is shown as follows:

n0	Function
0	Canceling download character set
1	Specifying download character set

[Default] n = 0

[See Also] ESC &

[Sample Program]

```

GOSUB SETCHR                                DATA 6
LPRINT CHR$(&H1B);"%"; CHR$(0);           DATA &HFF, &H80, &H00
LPRINT "@A"; CHR$(&HA);                     DATA &H80, &H80, &H00
LPRINT CHR$(&H1B);"%"; CHR$(1);           DATA &H80, &H80, &H00
LPRINT "@A"; CHR$(&HA);                     DATA &H80, &H80, &H00
END                                          DATA &HFF, &HFF, &HFF
SETCHR:                                     DATA &HFF, &HFF, &HFF
LPRINT CHR$(&H1B);"&";                       DATA 12
LPRINT CHR$(3);"@","A";                     DATA &HFF, &HFF, &HFF
FOR J=1 TO 2                                DATA &H80, &H07, &HF9
  READ REP                                   DATA &H80, &HFF, &HF9
  LPRINT CHR$(REP);                           DATA &H87, &HFE, &H01
  FOR I=1 TO REP*3                             DATA &H9F, &H06, &H01
    READ D                                       DATA &HF8, &H06, &H01
    LPRINT CHR$(D);                             DATA &HF8, &H06, &H01
  NEXT I                                       DATA &H9F, &H06, &H01
NEXT J                                       DATA &H87, &HFE, &H01
RETURN                                       DATA &H80, &HFF, &HF9
                                           DATA &H80, &H07, &HF9
                                           DATA &HFF, &HFF, &HFF
  
```

[Print Results]

@A ← Internal character set
 □ A ← Download character

ESC & s n m [a [p] s x a] m-n+1

[Function] Defining the download characters

[Code] <1B>H<26>H<s>H<n>H<m>H[<a>H<p1>H<p2>···<p s x a>]m – n + 1

[Range]
 s = 3 (Font A, B)
 s = 2 (Font C)
 32 ≤ n ≤ m ≤ 127
 0 ≤ a ≤ 12 (Font A)
 0 ≤ a ≤ 9 (Font B)
 0 ≤ a ≤ 8 (Font C)
 0 ≤ p1..p s x a ≤ 255

[Outline] Defines the font of download characters of alphanumeric characters.

- “s” indicates the number of bytes in vertical direction.
- “n” indicates the start character code and “m” the end character code. To define only one character, set n = m.
- Character codes definable includes 95 ASCII codes in total in the range of <20>H to <7E>H.
- “a” indicates the number of dots to be defined in horizontal direction.
- “p” is the data to be defined, which indicate a pattern equal to “a” dots in horizontal direction from the left end. The rest of the pattern on the right side is filled with space.
- The number of data to be defined is “s x a”.
- Download characters thus defined remain valid until redefinition, execution of ESC @, GS *, FS q, GS (A, deletion by ESC ?, or power OFF is performed.

[Caution]

- Download characters and download bit images cannot be defined simultaneously.
- Running this command clears the definition of the download bit image.

[Default] Same as the internal character set.

[See Also] ESC %, ESC ?

[Example]

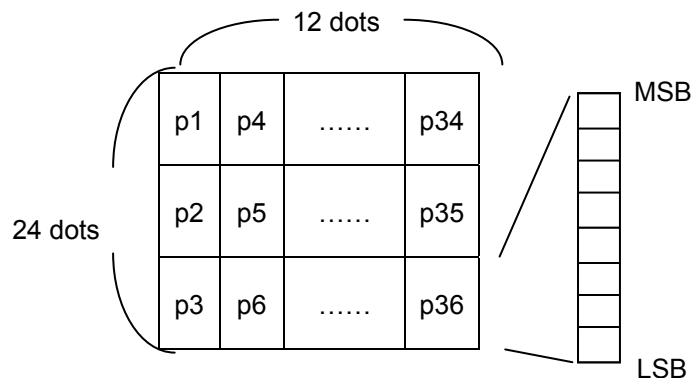

Font A

Create each data bit by setting “1” for a printed dot and “0” for an unprinted dot.

[Sample Program] Refer to Sample Program and Print Results for ESC %.

ESC – n

[Function] edifying/canceling underline

[Code] <1B>H<2D>H<n>

[Range] 0≤n≤2
48≤n≤50

[Outline] Specifying/canceling an underline.

n	Function
0, 48	Canceling underline
1, 49	Setting 1-dot width underline
2, 50	Setting 2-dot width underline

- [Caution]**
- An underline is attached to the full character width. It is, however, not attached to the part having been skipped by horizontal tab (HT) command.
 - An underline is not attached to 90°-right-turned characters and white-on-black character.
 - Underline can also be specified/canceled by ESC ! but the setting of command last processed is valid.
 - Specifying/canceling by this command is not valid for kanji.
 - Underline width is constant in the specified thickness regardless of the character size.

[Default] n = 0

[See Also] ESC !, FS –

[Sample Program]

```
LPRINT CHR$(&H1B);"-"; CHR$(0);
LPRINT "AAAAA";
LPRINT CHR$(&H1B);"-"; CHR$(1);
LPRINT "AAAAA"; CHR$(&HA);
```

[Print Results]

Underline canceled
 ↔
 A A A A A A A A A A
 ↔
 Underline specified

ESC ? n

[Function]	Deleting download characters
[Code]	<1B>H<3F>H<n>
[Range]	32≤n≤126
[Outline]	Deletes the downloaded characters of specified code.
[Caution]	<ul style="list-style-type: none">• The character “n” indicates the character code used to delete the defined pattern. After the deletion, characters are printed in the same pattern as the internal characters.• This command deletes the code-defined pattern of the character font selected by ESC !.• This command is ignored if the specified character code is undefined.
[See Also]	ESC &, ESC %

ESC E n

[Function] Specifying/canceling emphasis printing

[Code] <1B>H<45>H<n>

[Range] 0≤n≤255

[Outline] Specifying/canceling the emphasized characters.
• “n” is valid only for the lowest bit (n0).
• Control by the lowest bit (n0) is shown as follows:

n0	Function
0	Canceling emphasis printing
1	Specifying emphasis printing

[Caution] • Emphasis printing can also be specified/canceled by ESC ! but the setting of command last processed is valid.
• Valid for all character types except HRI characters.

[Default] n = 0

[See Also] ESC !

[Sample Program]
LPRINT CHR\$(&H1B);"E"; CHR\$(0);
LPRINT "AAABBB"; CHR\$(&HA);
LPRINT CHR\$(&H1B);"E"; CHR\$(1);
LPRINT "AAABBB"; CHR\$(&HA);

[Print Results]
AAABBB ← Emphasis canceled
AAABBB ← Emphasis specified

ESC G n

[Function] Specifying/canceling double strike printing

[Code] <1B>H<47>H<n>

[Range] 0≤n≤255

[Outline] Specifying/canceling the double strike printing.

- “n” is valid only for the lowest bit (n0).
- Control by the lowest bit (n0) is shown as follows:

n0	Function
0	Canceling double strike printing
1	Specifying double strike printing

[Caution]

- With this printer, double-strike printing and emphasis printing provide completely the same results.
- Valid for all character types except HRI characters.

[Default] n = 0

[See Also] ESC E

[Sample Program]

```
LPRINT CHR$(&H1B);"G"; CHR$(0);  
LPRINT "AAABBB"; CHR$(&HA);  
LPRINT CHR$(&H1B);"G"; CHR$(1);  
LPRINT "AAABBB"; CHR$(&HA);
```

[Print Results]

AAABBB ← Double strike printing canceled
AAABBB ← Double strike printing specified

ESC M n

[Function] Selection of character fonts

[Code] <1B>H<4D>H<n>

[Range] $0 \leq n \leq 2$
 $48 \leq n \leq 50$

[Outline] Selects character fonts.

n	Function
0, 48	Selection of font A (12 x 24)
1, 49	Selection of font B (9 x 24)
2, 50	Selection of font C (8 x 16)

[Caution]

- ESC ! can also select fonts, but the setting made by the command that has last been processed becomes valid.
- In case font C selection ESC R is other than n = 8 (katakana), codepage PC437 is printed.
- In case ESC R is n = 8 (katakana), codepage katakana is printed.

[Default] n = 0

[See Also] ESC !

ESC R n

[Function] Selecting the international character set

[Code] <1B>H<52>H<n>

[Range] $0 \leq n \leq 13$

[Outline] Depending on the value of "n", one of the following character sets is specified;

n	Character Set	n	Character Set
0	U.S.A.	7	Spain I
1	France	8	Japan
2	Germany	9	Norway
3	U.K.	10	Denmark II
4	Denmark I	11	Spain II
5	Sweden	12	Latin America
6	Italy	13	Korea

[Default] n = 0 (Overseas), n = 8 (Domestic)

[See Also] 3.2 "International Character Code Table"

ESC V n

[Function] Specifying/canceling 90°-right-turned characters

[Code] <1B>H<56>H<n>

[Range] $0 \leq n \leq 1$
 $48 \leq n \leq 49$

[Outline] Specifying/canceling 90°-right-turned characters.

n	Function
0, 48	Canceling 90°-right-turned characters
1, 49	Specifying 90°-right-turned characters

[Caution]

- No underlines are attached to 90°-right-turned characters.
- This command does not affect PAGE MODE but setting is maintained.

[Default] n = 0

[Sample Program]

```
LPRINT CHR$(&H1B);"V"; CHR$(0);  
LPRINT "AAAAA";  
LPRINT CHR$(&H1B);"V"; CHR$(1);  
LPRINT "AAAAA"; CHR$(&HA);
```

[Print Results]

90° rotation canceled

←→

A A A A A ▷ ▷ ▷ ▷ ▷

←→

90° rotation specified

ESC t n

[Function] Selecting the character code table

[Code] <1B>H<74>H<n>

[Range] 0≤n≤9
16≤n≤19
n = 26, 40, 255

[Outline] Selecting the character code table.
The character code table is selected based on the value of “n”.

n	Character Code Table
0	Codepage PC437
1	Katakana
2	Codepage PC850
3	Codepage PC860
4	Codepage PC863
5	Codepage PC865
6, 18	Codepage PC852
7, 17	Codepage PC866
8	Codepage PC857
9, 16	WPC1252
19	Codepage PC858
26	Thai code 18
40	Codepage PC864
255	Space Page (For user setting)

[Default] n=0 for overseas specifications
n=1 for Japanese Kanji specifications

[Sample Program]

```
LPRINT CHR$(&H1B);"t"; CHR$(0);
LPRINT "n=0 ";
LPRINT CHR$(C);
FOR C=&HB1 TO &HB5
NEXT C
LPRINT CHR$(&HA);
LPRINT CHR$(&H1B);"t"; CHR$(1);
LPRINT "n=1 ";
FOR C=&HB1 TO &HB5
    LPRINT CHR$(C);
NEXT C
LPRINT CHR$(&HA);
```

[Print Results]

```
n = 0   ☒   ↓
n = 1   アイウエ
```

ESC { n

[Function] Specifying/canceling the inverted characters

[Code] <1B>H<7B>H<n>

[Range] 0≤n≤255

[Outline] Specifying/canceling inverted characters.

- “n” is valid only for the lowest bit (n0).
- Control by the lowest bit (n0) is shown as follows:
- Turns the data of the line by 180° and print the data.

n0	Condition
0	Canceling inverted characters.
1	Specifying inverted characters.

[Caution]

- This command is valid only when it is specified at the beginning of a line.
- This command does not affect the PAGE MODE.

[Default] n = 0

[Sample Program]

```
LPRINT CHR$(&H1B); "{"; CHR$(0);
LPRINT "TEN"; CHR$(&HA);
LPRINT "ELEVEN"; CHR$(&HA);
LPRINT CHR$(&H1B); "{"; CHR$(1);
LPRINT "TEN"; CHR$(&HA);
LPRINT "ELEVEN"; CHR$(&HA);
```

[Print Results]

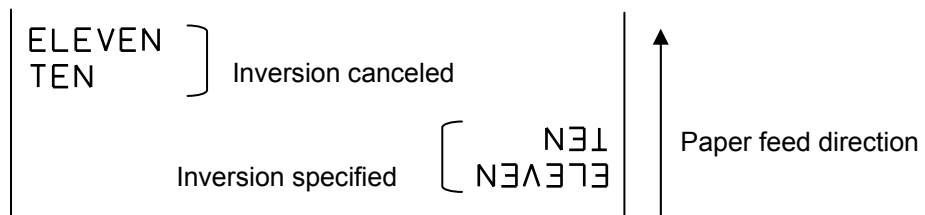

GS ! n

[Function] Specifying the character size

[Code] <1D>H<21>H<n>

[Range] $0 \leq n \leq 255$, where:
 $1 \leq \text{vertical magnification} \leq 8$, $1 \leq \text{horizontal magnification} \leq 8$

[Outline] Specifies the character size (Vertical and horizontal magnification).

Bit	Function	Value	
		Hex. Number	Decimal Number
0	Vertical magnification specification	Refer to Table 2, "Vertical Magnification".	
1			
2			
3			
4	Horizontal magnification specification	Refer to Table 1, "Horizontal Magnification".	
5			
6			
7			

Table 1 Horizontal Magnification

Hex.	Decimal	Magnification
00	0	1 x (Standard)
10	16	2 x (Double width)
20	32	3 x
30	48	4 x
40	64	5 x
50	80	6 x
60	96	7 x
70	112	8 x

Table 2 Vertical Magnification

Hex.	Decimal	Magnification
00	0	1 x (Standard)
01	1	2 x (Double)
02	2	3 x
03	3	4 x
04	4	5 x
05	5	6 x
06	6	7 x
07	7	8 x

- [Caution]**
- This command is valid for all characters (alphanumeric, kana, and kanji) except for HRI characters.
 - This command is ignored if either the vertical magnification or horizontal magnification is out of the defined range.
 - In STANDARD MODE, the vertical direction is defined as the paper feed direction, and the horizontal direction is defined as the direction perpendicular to the paper feed.
 - In PAGE MODE, the vertical direction means the top-bottom direction of each character. The horizontal direction means the side-to-side direction of each character. If characters of different vertical magnification are contained in a line, the baseline of each character is lined up.
 - Horizontal and vertical magnification can also be specified/canceled by ESC ! but the setting of command last processed is valid.

[Default] n = 0

[See Also] ESC !

GS B n

[Function] Specifying/canceling the black/white inverted printing

[Code] <1D>H<42>H<n>

[Range] $0 \leq n \leq 255$

[Outline] This command specifies or cancels the black/white inverted printing.

- “n” is valid only for the lowest bit (n0).
- Control by the lowest bit (n0) is shown as follows:

n0	Function
0	The black/white inverted printing is canceled.
1	The black/white inverted printing is specified.

[Caution]

- The black/white inversion works on internal and downloaded characters.
- The black/white inversion works also on the right spacing of characters defined by ESC SP.
- This command does not affect the bit image, downloaded bit image, bar code, HRI characters, or the skip area specified by HT, ESC \$, or ESC \.
- This command does not affect the space between lines.
- Black/white inversion specification takes precedence over underline specification. Underline printing specified is, therefore, nullified if black/white inversion is specified; the underline setting, however, remains unchanged.

[Default] n = 0

GS b n

[Function] Specifying/canceling the smoothing

[Code] <1D>H<62>H<n>

[Range] $0 \leq n \leq 255$

[Outline] This command specifies or cancels the smoothing.

- “n” is valid only for the lowest bit (n0).
- Control by the lowest bit (n0) is shown as follows:

n0	Function
0	The smoothing is canceled.
1	The smoothing is specified.

[Caution]

- Smoothing is effective to printer’s internal characters, download characters, and non-standard characters.
- Smoothing is not effective to characters with either of their vertical or horizontal magnification is x1.

[Default] n = 0

[See Also] ESC !, GS !

2.2.3 Print Position Commands

HT

[Function]	Horizontal tab
[Code]	<09>H
[Outline]	Shifts the printing position to the next horizontal tab position. • Ignored when the next horizontal tab position has not been set.
[Caution]	The horizontal tab position is set by ESC D.
[Default]	At the selection of font A, tabs are set every 8 characters (at 9th, 17th, 25th, ...) with right space amount of a character set at 0 and horizontal enlargement rate of a character set at 1.
[See Also]	ESC D

[Sample Program]

```
LPRINT "012345678901234567890"; CHR$(&HA);  
LPRINT CHR$(&H9);"AAA";  
LPRINT CHR$(&H9);"BBB"; CHR$(&HA);  
LPRINT CHR$(&H1B);"D";  
LPRINT CHR$(3); CHR$(7); CHR$(14);CHR$(0);  
LPRINT CHR$(&H9);"AAA";  
LPRINT CHR$(&H9);"BBB";  
LPRINT CHR$(&H9);"CCC"; CHR$(&HA);
```

[Printing Result]

```
12345678901234567890  
      AAA   BBB ← Initially set horizontal tab  
AAA   BBB   CCC ← When set to the 4th, 8th, and 15th columns
```

ESC \$ n1 n2

[Function] Specifying the absolute positions

[Code] <1B>H<24>H<n1><n2>

[Range] $0 \leq n1 \leq 255$
 $0 \leq n2 \leq 255$

[Outline] The printing start position is specified by the absolute position from the left margin with the number of dots divided by 256 and quotient specified as "n2" and remainder as "n1". Therefore, the printing start position is designated as $n1 + n2 \times 256$ x basic calculation pitch from the left margin.

[Caution]

- The basic calculation pitch is set by GS P. After the line feed width is set, if the basic calculation by GS P leaves a fraction, the fraction is corrected with the minimum pitch of the mechanism, and the remainder is omitted.
- In STANDARD MODE, this command uses the horizontal (Paper feed direction) basic calculation pitch (x).
- In PAGE MODE, this command acts differently depending on the start point:
 - (1) If the start point specified by ESC T is top right or bottom left, the command uses the vertical (Paper feed direction) basic calculation pitch (y).
 - (2) If the start point specified by ESC T is top left or bottom right, the command uses the horizontal (Perpendicular to the paper feed direction) basic calculation pitch (x). Specification beyond the end of the line is ignored.

[See Also] ESC \, GS P, GS \, GS \$

[Sample Program]

```
LPRINT CHR$(&H1B);"$";  
LPRINT CHR$(0); CHR$(0);"A";  
LPRINT CHR$(&H1B);"$";  
LPRINT CHR$(50); CHR$(0);"B";  
LPRINT CHR$(&H1B);"$";  
LPRINT CHR$(0); CHR$(1);"C"; CHR$(&HA);  
LPRINT CHR$(&H1B);"$";  
LPRINT CHR$(100); CHR$(0);"A";  
LPRINT CHR$(&H1B);" \";  
LPRINT CHR$(&HC2); CHR$(&HFF);"B"; CHR$(&HA);
```

[Print Results]

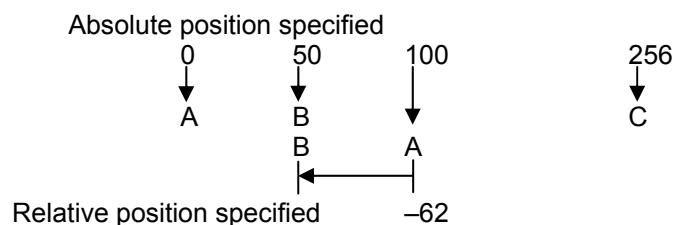

ESC D [n] k NULL

[Function]	Setting horizontal tab position
[Code]	<1B>H<44>H [<n>] k<00>H
[Range]	1≤n≤255 0≤k≤32
[Outline]	<p>Specifying a horizontal tab position.</p> <ul style="list-style-type: none">• “n” indicates the number of columns from the beginning to the horizontal tab position. Note, however, that “n = set position – 1”. For example, to set the position at 9th column, n = 8 is to be specified.• “k” denotes the number of horizontal tab positions you want to set.• The tab position is set at a position where it is “character width x n” from the beginning of a line. The character width, at this time, includes the space on the right. In double width characters, it is made double the ordinary case.• Tab positions that can be specified are maximum 32. Specifying tab positions exceeding this limit is ignored.• <n> k, which denotes a setting position, is input in the increasing order and ends at <00> H.• ESC D <NULL> clears all the set tab positions. Following clearing, the horizontal tab command is ignored.
[Caution]	<ul style="list-style-type: none">• When the data, <n> k, is equal to or smaller than its preceding data, <n> k-1, it is assumed that tab setting is finished. If this is the case, the next data onward will be processed as normal data.• When the data, <n> k, exceeds a 1-line print area, set the horizontal tab position, as “Set column position = Maximum print columns + 1”.• The horizontal tab position does not change even if the character width is altered after setting the horizontal tab position.
[Default]	<ul style="list-style-type: none">• At the selection of font A, tabs are set every 8 characters (at 9th, 17th, 25th, ...) with right space amount of a character set at 0 and horizontal enlargement rate of a character set at 1.
[See Also]	HT
[Sample Program]	Refer to Sample Program and Print Results for HT.

ESC T n

[Function] Selecting the character printing direction in PAGE MODE

[Code] <1B>H<54>H<n>

[Range] 0 ≤ n ≤ 3
48 ≤ n ≤ 51

[Outline] Selects the direction and start point of character printing in PAGE MODE.

n	Printing Direction	Start Point
0, 48	Left to right	Top left ("A" in the figure)
1, 49	Bottom to top	Bottom left ("B" in the figure)
2, 50	Right to left	Bottom right ("C" in the figure)
3, 51	Top to bottom	Top right ("D" in the figure)

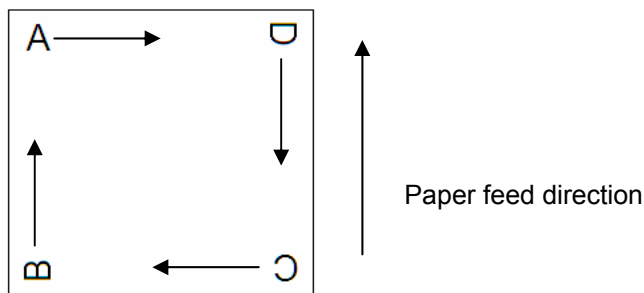

- [Caution]**
- When STANDARD MODE is selected, this command only executes the internal flagging of the printer without affecting the printing in STANDARD MODE.
 - The character mapping position will be the start point of the print area specified by ESC W.
 - The basic calculation pitch (x or y) used by the following commands varies with the start point.
 - (1) If the start point is the top left or bottom right (The characters are mapped in the direction perpendicular to the paper feed),
 - Commands using x: ESC SP, ESC S, ESC \
 - Commands using y: ESC 3, ESC J, GS \$, GS \
 - (2) If the start point is the top right or bottom left (The characters are mapped in the paper feed direction),
 - Commands using x: ESC 3, ESC J, GS \$, GS \
 - Commands using y: ESC SP, ESC S, ESC \

[Default] n = 0

[See Also] Appendix 4.1 "Explanation on PAGE MODE"
ESC \$, ESC L, ESC W, ESC \, GS \$, GS P, GS \

ESC W xL xH yL yH dxL dxH dyL dyH

- [Function]** Defining the print area in PAGE MODE
- [Code]** <1B>H<57>H<xL><xH><yL><yH><dxL><dxH><dyL><dyH>
- [Range]** $0 \leq xL, xH, yL, yH, dxL, dxH, dyL, dyH \leq 255$, except for $dxL = dxH = 0$ or $dyL = dyH = 0$
- [Outline]** Defines the location and size of the print area.
- Horizontal start point = $[(xL + xH \times 256) \times \text{basic calculation pitch}]$ inches
 - Vertical start point = $[(yL + yH \times 256) \times \text{basic calculation pitch}]$ inches
 - Horizontal length = $[(dxL + dxH \times 256) \times \text{basic calculation pitch}]$ inches
 - Vertical length = $[(dyL + dyH \times 256) \times \text{basic calculation pitch}]$ inches
- [Caution]**
- When STANDARD MODE is selected, this command only executes the internal flagging of the printer without affecting the printing in STANDARD MODE.
 - If the horizontal start point or vertical start point is out of the printable area, this command is canceled and the next data is handled as normal data.
 - If the horizontal length or vertical length is 0, this command is canceled and the next data is handled as normal data.
 - The character mapping position will be the start point specified by ESC T in the print area.
 - If the “horizontal start point + horizontal length” is greater than the horizontal printable area, the “horizontal printable area – horizontal start point” is taken as the horizontal length.
 - If the “vertical start point + vertical length” is greater than the vertical printable area, the “vertical printable area – vertical start point” is taken as the vertical length.
 - The basic calculation pitch is defined by GS P. Once defined, the print area is not changed if the basic calculation pitch is changed by GS P.
 - Fractions resulting from calculations are corrected with the minimum pitch of the mechanism, and the remainder is omitted.
 - The horizontal start point and horizontal length are calculated with the basic calculation pitch (x). The vertical start point and vertical length are calculated with the basic calculation pitch (y).
 - The figure below illustrates the print area, where X = horizontal start point, Y = vertical start point, Dx = horizontal length, and Dy = vertical length.

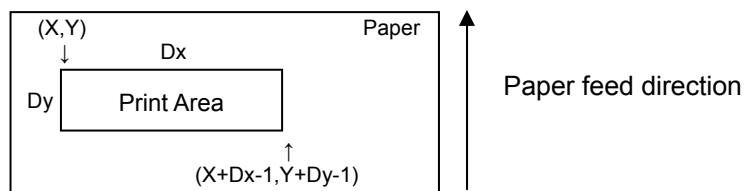

The printable area for this printer is approximately 72.070 mm (576/203 inches) horizontally and 117 mm (938/203 inches) vertically.

- [Default]** $xL = xH = yL = yH = 0$
 $dxL = 64, dxH = 2, dyL = 126, dyH = 6$

- [See Also]** Appendix 4.1 “Explanation on PAGE MODE”
CAN, ESC L, ESC T, GS P

ESC \ nL nH

[Function]	Specifying the relative position
[Code]	<1B>H<5C>H<nL><nH>
[Range]	0≤nL≤255 0≤nH≤255
[Outline]	This command specifies the next print start position in a relative position with respect to the current position. The next print start position will be at a point of [(nL + nH x 256) x basic calculation pitch] inches away from the current position.
[Caution]	<ul style="list-style-type: none">• Specification of a position outside the print area is ignored.• If a new position is specified to the right of the current position in the direction of printing, it should be specified as positive (+). If it is to the left, it should be as negative (-).• A negative value is the complement of 65536. For example, to move the position by N pitches to the left, specify it as: $nL + nH \times 256 = 65536 - N$• The basic calculation pitch is set by GS P.• Fractions resulting from calculation are corrected with the minimum pitch of the mechanism, and the remainder is omitted.• In STANDARD MODE, this command uses the horizontal basic calculation pitch (x).• In PAGE MODE, this command acts differently depending on the start point:<ol style="list-style-type: none">(1) If the start point specified by ESC T is top left or bottom right, the command specifies the relative position in the direction perpendicular to the paper feed (The character's side-to-side direction), using the horizontal basic calculation pitch (x).(2) If the start point is top right or bottom left, the command specifies the relative position in the paper feed direction (The character's side-to-side direction), using the vertical basic calculation pitch (y).
[See Also]	ESC \$, GS P
[Sample Program]	Refer to Sample Program and Print Results for ESC \$.

ESC a n

[Function] Aligning the characters

[Code] <1B>H<61>H<n>

[Range] 0 ≤ n ≤ 2
48 ≤ n ≤ 50

[Outline] All the printed data within one line are aligned in the specified position. Depending on the value “n”, positional alignment is carried out as shown in the table below:

n	Position
0, 48	Left end alignment
1, 49	Centering
2, 50	Right end alignment

[Caution] • This command is valid only when it is inputted at the beginning of a line.
• This command does not affect the PAGE MODE.
• Executes justification in the print area being set.

[Default] n = 0

[Sample Program]
LPRINT CHR\$(&H1B);"a"; CHR\$(0);
LPRINT "AAAAA"; CHR\$(&HA);
LPRINT CHR\$(&H1B);"a"; CHR\$(1);
LPRINT "AAAAA"; CHR\$(&HA);
LPRINT CHR\$(&H1B);"a"; CHR\$(2);
LPRINT "AAAAA"; CHR\$(&HA);

[Print Results]

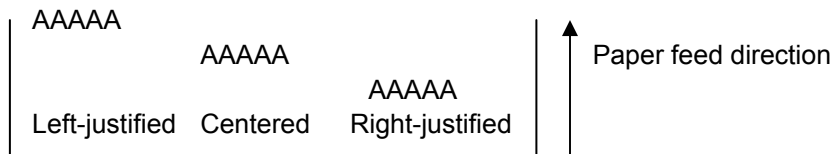

GS \$ nL nH

[Function]	Specifying the absolute position of character vertical direction in PAGE MODE
[Code]	<1D>H<24>H<nL><nH>
[Range]	0≤nL≤255, 0≤nH≤255
[Outline]	Specifies the vertical position of character at the start point of data development in PAGE MODE using absolute position based on the start position. The position of vertical direction of character at the start position of next data development is the position [(nL + nH x 256) x basic calculation pitch] from the start position.
[Caution]	<ul style="list-style-type: none">• This command is ignored except at PAGE MODE selection.• Absolute position setting exceeding the specified print area is ignored.• Position in horizontal direction of character at the start position of data development is not shifted.• Start point used as the reference is set by <ESC T>.• The following operation occurs at the start point of <ESC T>.<ol style="list-style-type: none">(1) When start point is set at “upper left” or “lower right”, the absolute position of paper feed direction (vertical direction of character) is set. In this case, basic calculation pitch (y) of vertical direction is used.(2) When start point is set at “upper right” or “lower left”, the absolute position of vertical direction of paper feed (vertical direction of character) is set. In this case, basic calculation pitch (x) of horizontal direction is used.• Basic calculation pitch is set by <GS P>.• When fractional number is caused by the calculation, it is corrected by the minimum pitch of mechanism and the rest is discarded.
[See Also]	ESC \$, ESC T, ESC W, ESC \, GS P, GS \

GS L nL nH

[Function] Setting the left margin

[Code] <1D>H<4C>H<nL><nH>

[Range] $0 \leq nL \leq 255$
 $0 \leq nH \leq 255$

[Outline] This command sets the left margin specified by nL and nH.
The value of the left margin is $[(nL + nH \times 256) \times \text{basic calculation pitch}]$ inches.

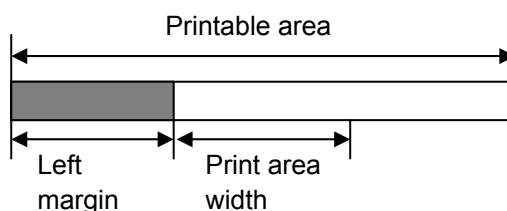

- [Caution]**
- This command only works when it is entered at the beginning of a line.
 - When PAGE MODE is selected, this command only executes the internal flagging of the printer.
 - The setting of this command does not affect PAGE MODE.
 - The maximum settable left margin is equal to the horizontal printable area. A setting greater than this maximum is trimmed to the maximum.
 - The basic calculation pitch is defined by GS P. Once defined, the left margin is not changed if the basic calculation pitch is changed by GS P.
 - The left margin is calculated with the horizontal basic calculation pitch (x) set by GS P. A fraction resulting from the calculation is corrected with the minimum pitch of the mechanism, and the remainder is omitted.
 - When mapping character data, if the print area specified is not wide enough to accommodate one character of the current font, only the line for that character data is handled as follows:
 - (1) The print area is extended toward the right to be equivalent to one character of the current font, but not wider than the printable area.
 - (2) If an area for one character cannot be provided as a result of step (1), the print area is extended toward the left. (So, the left margin is decreased.)
 - When mapping non-character data (bit image, downloaded bit image, or bar code), if the print area specified is narrower than 9-bits, only the line for that data is handled as follows:
 - (1) The print area is extended toward the left (so, the left margin is decreased) until it is 9-dot wide, but not wider than the printable area.

[Default] nL = 0, nH = 0

[See Also] GS P, GS W

GS W nL nH

[Function] Setting the print area width

[Code] <1D>H<57>H<nL><nH>

[Range] $0 \leq nL \leq 255$
 $0 \leq nH \leq 255$

[Outline] Sets the print area width specified by nL and nH.
 The print area width will be $[(nL + nH \times 256) \times \text{basic calculation pitch}]$ inches.

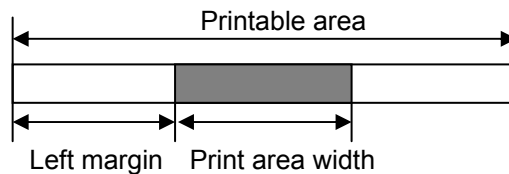

- [Caution]**
- This command only works when it is entered at the beginning of a line.
 - When PAGE MODE is selected, this command only executes the internal flagging of the printer.
 - The setting of this command does not affect PAGE MODE.
 - If the value entered with this command exceeds the printable area for one line, the entire area except the left margin is set as the print area width.
 - The basic calculation pitches are defined by GS P. Once defined, the print area width is not changed if the basic calculation pitch is changed by GS P.
 - The print area width is calculated with the horizontal basic calculation pitch (x) defined by GS P. A fraction resulting from the calculation is corrected with the minimum pitch of the mechanism, and the remainder is omitted.
 - If the first character to be mapped at the beginning of a line has a width (including the right spacing) greater than the print area width, only that line is handled as follows:
 - (1) The print area is extended toward the right to accommodate the first character, but not wider than the printable area.

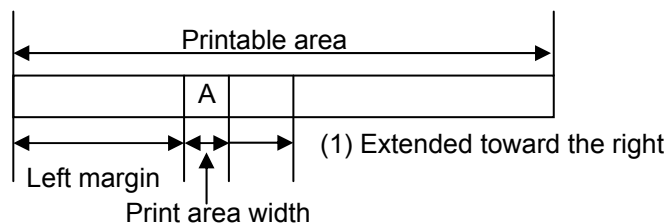

(2) If a sufficient area cannot be provided as a result of step (1), the print area is extended toward the left (so, the left margin is decreased).

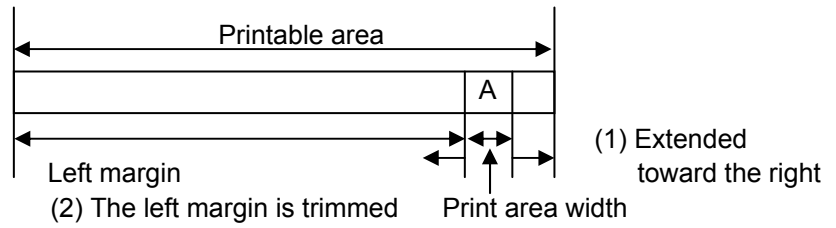

(3) If a sufficient area cannot be provided as a result of step (2), the right spacing is trimmed.

- When mapping a bit image (or downloaded bit image), if the print area is narrower than the minimum width of the bit image (two dots for single density, or one dot for double density), only the line for that image is handled as follows:

(1) The print area is extended toward the left (so, the left margin is decreased) until it is equal to the minimum width of the image, but not wider than the printable area.

[Default] nL = 64, nH = 2

[See Also] GS L, GS P

GS \ nL nH

[Function]	Specifying the relative vertical position of a character in PAGE MODE
[Code]	<1D>H<5C>H<nL><nH>
[Range]	0≤nL≤255 0≤nH≤255
[Outline]	This command is used in PAGE MODE to specify the vertical position of a character in the data mapping start position, in a relative position with respect to the current position. The next data mapping start position will be at a point [(nL + nH x 256) x basic calculation pitch] inches away from the current position.
[Caution]	<ul style="list-style-type: none">• This command is ignored when PAGE MODE is not selected.• If a new position is specified for a character located beneath the current position, it should be specified as positive (+). If it is above the current position, it should be negative (-).• A negative value is the complement of 65536. For example, to move the position by N pitches up, specify it as: $nL + nH \times 256 = 65536 - N$• The specification of a relative position outside the specified print area is ignored.• Depending on the start point specified by ESC T, this command acts as follows:<ol style="list-style-type: none">(1) If the start point is the top left or bottom right, the command specifies the relative position in the paper feed direction (the character's top-bottom direction) using the vertical basic calculation pitch (y).(2) If the start point is the top right or bottom left, the command specifies the relative position in the direction perpendicular to the paper feed (the character's top-bottom direction) using the horizontal basic calculation pitch (x).• The basic calculation pitch is set by GS P.• Fractions resulting from calculations are corrected with the minimum pitch of the mechanism, and the remainder is omitted.

2.2.4 Line Feed Span Commands

ESC 2

- [Function]** Specifying 1/6-inch line feed rate
- [Code]** <1B>H<32>H
- [Outline]** The line feed rate per line is specified by 1/6 inch.
- [Caution]** Line feed rate can be specified respectively for both STANDARD MODE and PAGE MODE.

[Sample Program]

```
LPRINT "AAAAA"; CHR$(&HA);  
LPRINT CHR$(&H1B);"3"; CHR$(0);  
LPRINT "AAAAA"; CHR$(&HA);  
LPRINT CHR$(&H1B);"3"; CHR$(50);  
LPRINT "AAAAA"; CHR$(&HA);  
LPRINT CHR$(&H1B);"2";  
LPRINT "AAAAA"; CHR$(&HA);  
LPRINT "AAAAA";  
LPRINT CHR$(&H1B);"J"; CHR$(100);  
LPRINT "AAAAA"; CHR$(&HA);  
LPRINT "AAAAA"; CHR$(&HA);
```

[Print Results]

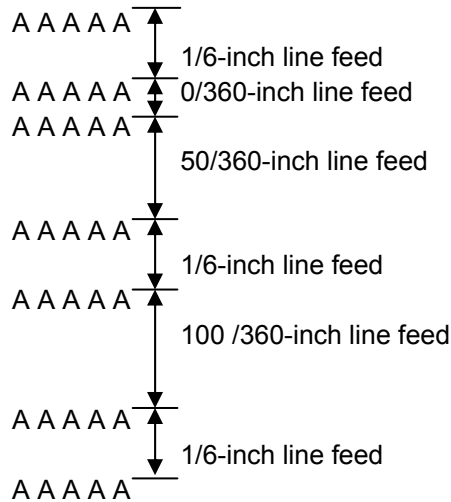

ESC 3 n

[Function]	Setting line feed rate of minimum pitch
[Code]	<1B>H<33>H<n>
[Range]	0≤n≤255
[Outline]	Sets the line feed width per line to [n x basic calculation pitch] inches.
[Caution]	<ul style="list-style-type: none">• The line feed width can be set separately for the STANDARD and PAGE MODES.• The basic calculation pitch is set by GS P. Once defined, the line feed width is not changed if the basic calculation pitch is changed by GS P.• Fractions resulting from calculation are corrected with the minimum pitch of the mechanism, and the remainder is omitted.• In STANDARD MODE, this command uses the vertical (paper feed direction) basic calculation pitch (y).• In PAGE MODE, this command acts differently depending on the start point:<ul style="list-style-type: none">(1) If the start point specified by ESC T is top left or bottom right, the command uses the vertical (paper feed direction) basic calculation pitch (y).(2) If the start point specified by ESC T is top right or bottom left, the command uses the horizontal (perpendicular to the paper feed direction) basic calculation pitch (x).• The maximum settable line feed width is 1016 mm (40 inches). A setting greater than this maximum is trimmed to the maximum.
[Default]	Approx. 4.23 mm
[See Also]	ESC 2, GS P

2.2.5 Bit Image Commands

ESC * m n1 n2 [d] k

[Function] Specifying the bit image mode

[Code] <1B>H<2A>H<m>H<n1><n2>[<d>]k

[Range] m = 0, 1, 32, 33
 $0 \leq n1 \leq 255$
 $0 \leq n2 \leq 2$
 $0 \leq d \leq 255$
 $k = n1 + 256 \times n2$ (m = 0, 1)
 $k = (n1 + 256 \times n2) \times 3$ (m = 32, 33)

- [Outline]**
- According to the number of dots specified in “n1”, “n2”, specify the bit image of mode “m”.
 - The number of dots printed is divided by 256, whose quotient is taken as n2 and residual as “n1”. The total number of dots printed in the horizontal direction is equal to $n1 + (256 \times n2)$.
 - When bit image data have been input in excess of dot positions that can be printed on one line, the excess data are discarded.
 - “d” is bit image data. Bits to be printed are specified as “1” and those not as “0”.
 - The bit image modes specified by “m” are shown as follows:

m	Mode	Vertical Direction		Horizontal Direction	
		No. of Dots	Dot Density	Dot Density	Max. No. of Dots
0	8-dots single density	8	67 DPI	101 DPI	288
1	8-dots double density	8	67 DPI	203 DPI	576
32	24-dots single density	24	203 DPI	101 DPI	288
33	24-dots double density	24	203 DPI	203 DPI	576

- [Caution]**
- When the value of “m” is out of the above range, the data following after “n1” is processed as normal printing data.
 - After completion of bit image printing, the printer returns to normal data processing mode.

[Sample Program]

```
LPRINT CHR$(&H1B);"*";
LPRINT CHR$(0);CHR$(20);CHR$(0);
GOSUB IMG1
LPRINT CHR$(&HA);
LPRINT CHR$(&H1B);"*";
LPRINT CHR$(1);CHR$(20);CHR$(0);
GOSUB IMG1
LPRINT CHR$(&HA);
LPRINT CHR$(&H1B);"*";
LPRINT CHR$(32);CHR$(20);CHR$(0);
GOSUB IMG2
LPRINT CHR$(&HA);
LPRINT CHR$(&H1B);"*";
LPRINT CHR$(33);CHR$(20);CHR$(0);
GOSUB IMG2
LPRINT CHR$(&HA);
END

IMG1:
LPRINT CHR$(&HFF);
FOR I = 1 TO 18
    LPRINT CHR$(&H85);
NEXT I
LPRINT CHR$(&HFF);
RETURN

IMG2:
LPRINT CHR$(&HFF);
LPRINT CHR$(&HFF);
LPRINT CHR$(&HFF);
FOR I = 1 TO 18
    LPRINT CHR$(&H80);
    LPRINT CHR$(&H00);
    LPRINT CHR$(&H05);
NEXT I
LPRINT CHR$(&HFF);
LPRINT CHR$(&HFF);
LPRINT CHR$(&HFF);
RETURN
```

[Print Results]

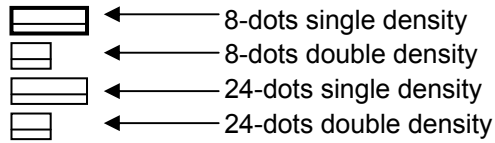

GS * n1 n2 [d] n1 x n2 x 8

[Function] Defining the download bit image

[Code] <1D>H<2A>H<n1><n2> [<d >] n1 x n2 x 8

[Range]
 $1 \leq n1 \leq 255$
 $1 \leq n2 \leq 48$
 $n1 \times n2 \leq 1536$

[Outline]

- Defines download bit images of the number of dots specified by “n1” and “n2”.
- The numbers of dots are n1 x8 in horizontal direction and n2 x8 in vertical direction.
- ”d” indicates bit image data.
- Once defined, the download bit image remains effective until it is redefined, ESC @, ESC &, GS (A, or FS q, is executed, or power is turned OFF.

[Caution]

- Relations between the bit image data and the dots defined are shown below.
- With this command executed, the defined content of a downloaded character is cleared.

[See Also] GS /

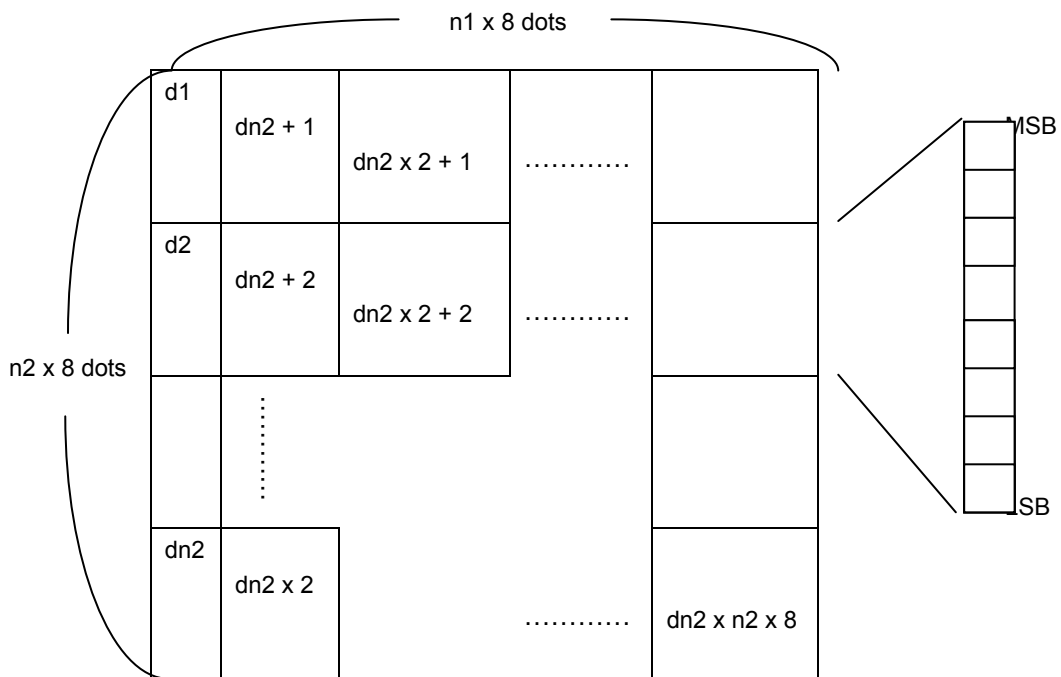

[Sample Program]

```
GOSUB IMG
LPRINT CHR$(&H1D);"/"; CHR$(0);
LPRINT CHR$(&H1D);"/"; CHR$(1);
LPRINT CHR$(&H1D);"/"; CHR$(2);
LPRINT CHR$(&H1D);"/"; CHR$(3);
END
IMG:
n1=10:n2=5
LPRINT CHR$(&H1D);"*";
LPRINT CHR$(n1); CHR$(n2);
FOR J=1 TO n1*8
  FOR I=1 TO n2
    LPRINT CHR$(J);
  NEXT I
NEXT J
RETURN
```

[Print Results]



The print results show a grid of characters. The first four rows consist of slashes followed by a space and a character from the set {0, 1, 2, 3}. The next four rows consist of slashes followed by a space and a character from the set {*, 10, 11, 12, 13}. The final four rows consist of slashes followed by a space and a character from the set {1, 2, 3, 4, 5, 6, 7, 8, 9, 10, 11, 12, 13, 14, 15, 16, 17, 18, 19}.

GS / m

[Function] Printing the downloaded bit image

[Code] <1D>H<2F>H<m>

[Range] 0≤m≤3
48≤m≤51

[Outline] Prints downloaded bit image in a mode specified by “m”.
Modes that can be selected by “m” are shown below.

m	Mode Name	Dot Density in Vertical Direction	Dot Density in Horizontal Direction
0, 48	NORMAL MODE	203 DPI	203 DPI
1, 49	DOUBLE WIDTH MODE	203 DPI	101 DPI
2, 50	DOUBLE HEIGHT MODE	101 DPI	203 DPI
3, 51	QUADRUPLE SIZE MODE	101 DPI	101 DPI

[Caution]

- When a downloaded bit image has not been defined, this command is ignored.
- When data exist in the print buffer, this command is ignored.
- A portion of a downloaded bit image exceeding one line length is not printed.

[See Also] ESC &, GS *

GS v 0 m xL xH yL yH d1...dk

[Function] Printing of raster bit image

[Code] <1D>H<76>H<30>H<m><xL><xH><yL><yH> [<d>] k

[Range] $0 \leq m \leq 3$, $48 \leq m \leq 51$, $0 \leq xL \leq 255$, $0 \leq xH \leq 255$,
 $0 \leq yL \leq 255$, $0 \leq yH \leq 8$, $0 \leq d \leq 255$,
 $k = (xL + xH \times 256) \times (yL + yH \times 256)$, however, $k \neq 0$

[Outline] Prints raster bit images in mode “m”.

- xL, xH specify the number of data in horizontal direction of the bit image to $(xL + xH \times 256)$ bytes.
- yL, yH specify the number of data in vertical direction of the bit image to $(yL + yH \times 256)$ bytes.

m	Mode Name	Dot Density in Vertical Direction	Dot Density in Horizontal Direction
0, 48	NORMAL MODE	203 DPI	203 DPI
1, 49	DOUBLE WIDTH MODE	203 DPI	101 DPI
2, 50	DOUBLE HEIGHT MODE	101 DPI	203 DPI
3, 51	QUADRUPLE SIZE MODE	101 DPI	101 DPI

[Caution]

- In STANDARD MODE, this command is valid only when there is no print data in the print buffer.
- Any of the print modes (character size, emphasis, double strike, inverting, underlining, back-to-white reversing, etc.) does not affect the raster bit image.
- If the print area specified by GS L and GS W is narrower than a minimum width, the print area for that line only is extended to the minimum width. The minimum width is one dot in NORMAL MODE (m = 0, 48) and DOUBLE HEIGHT MODE (m = 2, 50), and 2 dots in DOUBLE WIDTH MODE (m = 1, 49) and QUADRUPLE SIZE MODE (m = 3, 51).
- Any part of data that is out of the print area is only read and discarded in units of dot.
- The print start position can arbitrarily be specified with HT (horizontal tab), ESC \$ (specifying absolute position), ESC \ (specifying relative positions), and GS L (setting left margins). Note that if the print start position is not a multiple of 8, the printing speed may decrease.
- The setting of ESC a (aligning characters) are also valid for the raster bit image.
- If this command is executed during macro definition, the macro definition is suspended, and the processing of the command starts. The macro is left undefined.
- “d” denotes defined data. Dots to be printed are specified as “1”, and those not to be printed as “0”.

[Example]

When $x_L + x_H \times 256 = 64$

← $(x_L + x_H \times 256)$ 8 dots = 512 dots →

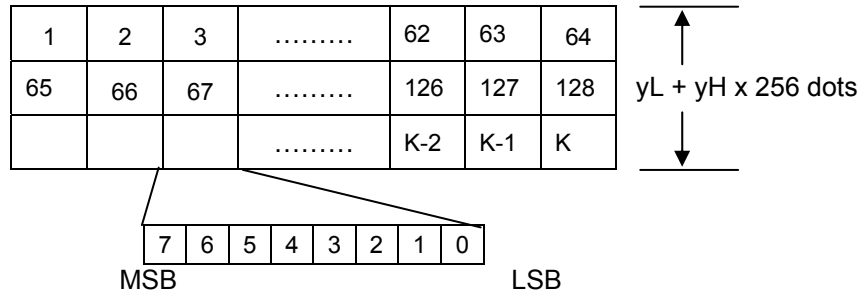

2.2.6 Status Commands

DLE EOT n

[Function]	Sending status in real-time
[Code]	<10>H<04>H<n>
[Range]	1≤n≤4
[Outline]	Sends in real-time the status specified by “n”.

n	Status
1	Printer status
2	Status caused by an offline condition
3	Status caused by an error
4	Continuous paper detector status

- [Caution]**
- Each status represents the current status. It is 1 byte data.
 - The status is transferred without checking whether the host is ready to receive or busy.
 - This command is executed even if the printer is in offline state, receive-buffer full state, or error state.
 - This command is dealt with when it is received.
 - With serial interface specifications, this command is executed in offline state, receiving buffer full state, and error state.
 - With parallel interface specifications, this command cannot be executed while the printer is in Busy state.
When memory SW1-3 is ON, the printer does not enter Busy state in the offline state and error state.
 - If ASB (Automatic Status Back) is enabled by GS a, it is necessary to discriminate between the status due to ASB and the status due to this command.
 - This command can be executed even if printer setting by ESC = is invalid.
 - If another data string of <10>H<04>H<n> (1 n 4) is received, the printer acts the same way as with this command. Therefore, the user should be reminded of this fact.

[Example 1]

Suppose a command “ESC * m nL nH [d1 ... dk]”, where d1 = <10>H, d2 = <04>H, d3 = <01>H.

The DLE EOT n command cannot be interleaved into the code string of another command consisting of 2 bytes or more.

[Example 2]

If the printer sends DLE EOT 3 after the host has sent up to ESC 3 in its attempt to send ESC 3 n, the printer handles the ESC 3 as ESC 3 <10>H. Thus, the user should be cautious.

(1) Printer status (When n = 1 is specified)

Bit	Status	Hex.	Decimal
0	Fixed	00	0
1	Fixed	02	2
2	Fixed	04	4
3	Online status	00	0
	Offline status	08	8
4	Fixed	10	16
5	Not waiting online recovery	00	0
	Waiting online recovery	20	32
6	LF-SW signal is High-Level	00	0
	LF-SW signal is Low-Level	40	64
7	Fixed	00	0

(2) Status caused by an offline condition (When n = 2 is specified)

Bit	Status	Hex.	Decimal
0	Unused	00	0
1	Unused	02	2
2	Head-down	00	0
	Head-up	04	4
3	Not in paper feed state triggered by LF-SW signal	00	0
	In paper feed state triggered by LF-SW signal	08	8
4	Unused	10	16
5	Printing is not stopped because of "paper out" state	00	0
	Printing is stopped because of "paper out" state	20	32
6	Error not occurred	00	0
	Error occurred	40	64
7	Unused	00	0

Bit 5: Printing is stopped if the Paper-end detector detects a "paper out" state, or if the printer is out of paper when the Paper Near-end Sensor is enabled by ESC c 4. At this time, bit 5 = 1.

(3) Status caused by an error (when n = 3 is specified)

Bit	Status	Hex.	Decimal
0	Fixed	00	0
1	Fixed	02	2
2	Fixed	00	0
3	Auto cutter error not occurred	00	0
	Auto cutter error occurred	08	8
4	Fixed	10	16
5	Unrecoverable error not occurred	00	0
	Unrecoverable error occurred	20	32
6	Auto recovery error not occurred	00	0
	Auto recovery error occurred	40	64
7	Fixed	00	0

Bit 3: If this error occurred because of a paper jam, for example, remove the cause of the error, and then DLE ENQ n (1 n 2) can be used to recover from the error. However, it is not possible to recover from any error due to a circuit problem (e.g., broken wire).

Bit 6: If a head overheat error is detected, the printing is stopped until the head temperature falls. At this time, bit 6 = 1.

(4) Continuous paper detector status (When n = 4 is specified)

Bit	Status	Hex.	Decimal
0	Fixed	00	0
1	Fixed	02	02
2	Paper found by Paper Near-end Sensor	00	0
	Paper not found by Paper Near-end Sensor	04	4
3	Paper found by Paper Near-end Sensor	00	0
	Paper not found by Paper Near-end Sensor	08	8
4	Fixed	10	16
5	Paper found by Paper-end Sensor	00	0
	Paper not found by Paper-end Sensor	20	32
6	Paper found by Paper-end Sensor	00	0
	Paper not found by Paper-end Sensor	40	64
7	Fixed	00	0

[See Also]

Appendix 4.3 "Identification of Send Status"
DLE ENQ, ESC c 4, GS a, GS r

GS a n

[Function] Enabling/disabling ASB (Automatic Status Back)

[Code] <1D>H<61>H<n>

[Range] 0≤n≤255

[Outline] This command selects the status item to be addressed by ASB (Automatic Status Back.)

Bit	Status Item Addressed by ASB	Hex.	Decimal
0	Undefined	—	—
1	Online/offline status = Disabled	00	0
	Online/offline status = Enabled	02	2
2	Error status = Disabled	00	0
	Error status = Enabled	04	4
3	Continuous Paper Sensor = Disabled	00	0
	Continuous Paper Sensor = Enabled	08	8
4	Undefined	—	—
5	Undefined	—	—
6	Undefined	—	—
7	Undefined	—	—

- [Caution]**
- If any status item is enabled, the status is sent to the host when this command is executed. After that time on, the status is sent each time an enabled status item changes. Because each status item represents the current condition, status items disabled for ASB may also have changed.
 - The ASB function is disabled if all status items are disabled.
 - If the ASB function is enabled by default, the host receives the status the first time the printer gets ready for communication after it is turned on.
 - The printer sends 4 bytes of status shown in the tables below, without checking whether the host is ready to receive or busy. The 4 bytes of status is a continuous string except for XOFF code.
 - Because this command is executed when data is mapped in the receive buffer, there may be a delay between command receiving and status sending depending on the condition of the receive buffer.
 - Even if the printer is excluded from the selection of peripheral equipment ESC =, the 4 bytes of status is sent to the host whenever status changes.
 - When DLE EOT, GS I, or GS r is used, the host must discriminate between the status specified by these commands and the status due to ASB.

(1) 1st byte (Printer information)

Bit	Status	Hex.	Decimal
0	Unused	00	0
1	Unused	00	0
2	Unused	00	0
3	Online status	00	0
	Offline status	08	8
4	Unused	10	16
5	Head-down	00	0
	Head-up	20	32
6	Not in paper feed state triggered by LF-SW signal	00	0
	In paper feed state triggered by LF-SW signal	40	64
7	Unused	00	0

(2) 2nd byte (Error occurrence information)

Bit	Status	Hex.	Decimal
0	Undefined	—	—
1	Undefined	—	—
2	Unused	00	0
3	Auto cutter error not occurred	00	0
	Auto cutter error occurred	08	8
4	Unused	00	0
5	Unrecoverable error not occurred	00	0
	Unrecoverable error occurred	20	32
6	Auto recovery error not occurred	00	0
	Auto recovery error occurred	40	64
7	Unused	00	0

(3) 3rd byte (Paper Sensor information)

Bit	Status	Hex.	Decimal
0, 1	Paper found by Paper Near-end Sensor	00	0
	Paper not found by Paper Near-end Sensor	03	3
2, 3	Paper found by Paper-end Sensor	00	0
	Paper not found by Paper-end Sensor	0C	12
4	Unused	00	0
5	Undefined	—	—
6	Undefined	—	—
7	Unused	00	0

(4) 4th byte (Paper Sensor information)

Bit	Status	Hex.	Decimal
0	Reserved	01	1
1	Reserved	02	2
2	Reserved	04	4
3	Reserved	08	8
4	Fixed	00	0
5	Reserved	00	0
6	Reserved	00	0
7	Fixed	00	0

[Default] When MSW 1-3 OFF: n = 0
When MSW 1-3 ON: n = 2

[See Also] DLE EOT, GS r

GS r n

- [Function]** Sending status
- [Code]** <1D>H<72>H<n>
- [Range]** n=1,49
- [Outline]** Sends the specified status to the host.

n	Function
1, 49	Sends the Paper Sensor status.

- [Caution]**
- When the serial interface is used:
 - For DTR/DSR control:
The printer sends the status after verifying that the host is ready to receive. If the host is not ready to receive, the printer waits for the host to become ready to receive.
 - For XON/XOFF control:
The printer sends the status without checking whether the host is ready to receive or busy.
 - Because this command is executed when data is mapped in the receive buffer, there may be a delay between receiving the command and sending the status depending on the condition of the receive buffer.
 - If ASB (Automatic Status Back) is enabled by GS a, the host must discriminate between the status due to this command and the status due to ASB.
 - Paper Sensor status (n = 1, 49)

Bit	Status	Hex.	Decimal
0, 1	Paper found by Paper Near-end Sensor	00	0
	Paper not found by Paper Near-end Sensor	03	3
2, 3	Paper found by Paper-end Sensor	00	0
	Paper not found by Paper-end Sensor	(0C)	(12)
4	Unused	00	0
5	Undefined	—	—
6	Undefined	—	—
7	Unused	00	0

Bits 2, 3: Whenever the Paper-end Sensor detects a “paper out” state, the printer goes offline, and the command is not executed. Therefore, the printer never sends a status “No paper in Paper-end detector (0CH)”

- [See Also]** Appendix 4.3 “Identification of Send Status”
DLE EOT, GS a

2.2.7 Paper Detecting Commands

ESC c 3 n

[Function] Selecting the Paper Sensor valid for a Paper-end signal output

[Code] <1B>H<63>H<33>H<n>

[Range] $0 \leq n \leq 255$

[Outline] This command selects by which Paper Sensor a Paper-end signal should be output. Each bit for “n” has the following meaning:

Bit	Position	Value	
		0	1
0	Paper Near-end	Disabled	Enabled
1	Paper Near-end	Disabled	Enabled
2	Paper-end	Disabled	Enabled
3	Paper-end	Disabled	Enabled
4	Undefined	—	—
5	Undefined	—	—
6	Undefined	—	—
7	Undefined	—	—

[Caution] This command is valid only for the parallel interface.

[Default] n = 15

ESC c 4 n

[Function] Selecting the Paper Near-end Sensor valid for print stop

[Code] <1B>H<63>H<34>H<n>

[Range] $0 \leq n \leq 255$

[Outline] This command selects the Paper Near-end Sensor which helps to stop printing when the paper supply almost runs out.
Each bit for “n” has the following meaning:

Bit	Position	Value	
		0	1
0	Paper Near-end	Disabled	Enabled
1	Paper Near-end	Disabled	Enabled
2	Undefined	—	—
3	Undefined	—	—
4	Undefined	—	—
5	Undefined	—	—
6	Undefined	—	—
7	Undefined	—	—

[Caution] This printer can only select one kind of Paper Sensor, a Paper Near-end Sensor.

[Default] n = 0

2.2.8 Panel Switch Commands

ESC c 5 n

[Function] Enabling/disabling LF-SW signal

[Code] <1B>H<63>H<35>H<n>

[Range] $0 \leq n \leq 255$

[Outline] Enabling/disabling LF-SW signal.

- "n" is valid only for the lowest bit (n0).
- Control by the lowest bit (n0) is shown as follows:

n0	Condition
0	LF-SW signal valid
1	LF-SW signal invalid

[Caution]

- When the LF-SW signal is disabled with this command, the paper cannot be fed by operating the LF-SW signal.
- While switch operation is waited at the execution of macro, the LF-SW signal is always enabled regardless of the setting of this command but no paper feed operation is carried out.

[Default] n = 0

[Sample Program]

```
LPRINT CHR$(&H1B);"c5"; CHR$(0); ← When enabling the LF-SW signal
LPRINT CHR$(&H1B);"c5"; CHR$(1); ← When disabling the LF-SW signal
```

2.2.9 Macro Commands

GS :

- [Function]** Starting/ending macro definition
- [Code]** <1D>H<3A>H
- [Outline]** Specifying starting/ending macro definition.
Reception of this command during macro definition signifies ending the macro definition.
- [Caution]**
- Maximum content available for macro definition is 2048 bytes. A portion exceeding 2048 bytes is not defined.
 - When GS ^ is processed in macro definition, the macro definition is stopped and the content of definition is cleared.
 - Even with ESC @ (Initialization of the printer) having been executed, defined content is not cleared. Therefore, it is possible to include ESC @ into the content of macro definition.
 - Normal printing operation is carried out even during macro definition.

[Default] The initial value is not defined.

[See Also] GS ^

[Sample Program]

```
LPRINT CHR$(&H1D);":";
LPRINT "+-----+"; CHR$(&HA);
LPRINT "|      |"; CHR$(&HA);
LPRINT "+-----+"; CHR$(&HA);
LPRINT CHR$(&H1D);":";
LPRINT CHR$(&H1D);"^";
LPRINT CHR$(2); CHR$(10);
```

[Print Results]

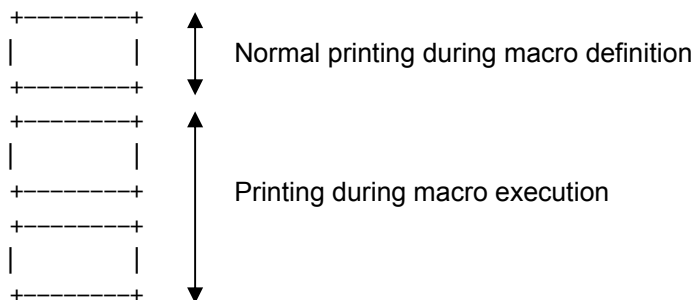

GS ^ n1 n2 n3

[Function]	Executing the macro
[Code]	<1D>H<5E>H<n1><n2><n3>
[Range]	0≤n1≤255 0≤n2≤255 0≤n3≤1
[Outline]	Executing contents defined in macro. n1 : The number of times of macro execution n2 : Waiting time on macro execution: Waiting time of n2 x 100 msec is given for every execution. n3 : Macro execution mode n3 = 0 Continuous execution: The Macro is executed “n1” times continuously at the time interval specified by “n2”. n3 = 1 Execution by FEED Switch: After waiting for the time specified by “n2”, the ARARM LED flickers and the FEED switch is waiting to be pressed. When it is pressed, the macro is executed once. This action is repeated “n1” times.
[Caution]	<ul style="list-style-type: none">• When this command is received while in macro definition, suspension of macro definition is indicated. At this time, the defined content is cleared.• No execution takes place when the macro is held undefined.• While in macro execution with n3 = 1, paper feed with the FEED switch is not available.
[See Also]	GS :
[Sample Program]	Refer to Sample Program and Print Results for GS:.

2.2.10 Cutter Commands

ESC i

[Function] Full cutting of paper

[Code] <1B>H<69>H

[Outline] Executes full cutting of paper.

[Caution]

- This command only works if it is entered at the beginning of a line.
- Before cutting paper, feed the paper more than the cutting position of paper from the print position. Without this paper feeding, the character just after printing remains before the cutter.

[Sample Program]

```
LPRINT "AAAAA";  
LPRINT CHR$(&H1B);"J";  
LPRINT CHR$(150);  
LPRINT CHR$(&H1B);"i";
```

[Print Results]

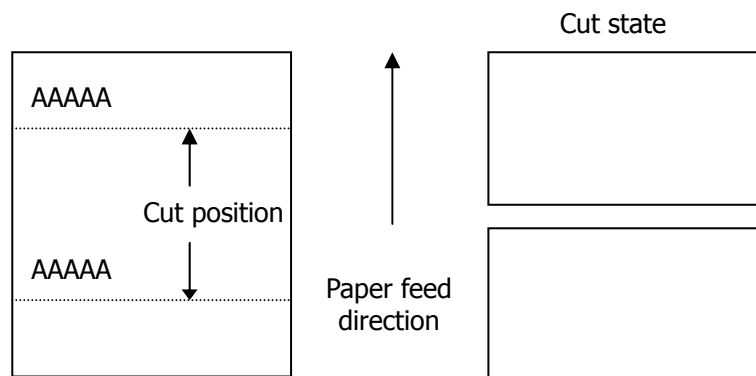

ESC m

[Function] Partial cutting of paper

[Code] <1B>H<6D>H

[Outline] Executes partial cutting of paper.

[Caution]

- This command only works if it is entered at the beginning of a line.
- Before cutting paper, feed the paper more than the cutting position of paper from the print position. Without this paper feeding, the character just after printing remains before the cutter.

[Sample Program]

```
LPRINT "AAAAA";  
LPRINT CHR$(&H1B);"J";  
LPRINT CHR$(150);  
LPRINT CHR$(&H1B);"m";
```

[Print Results]

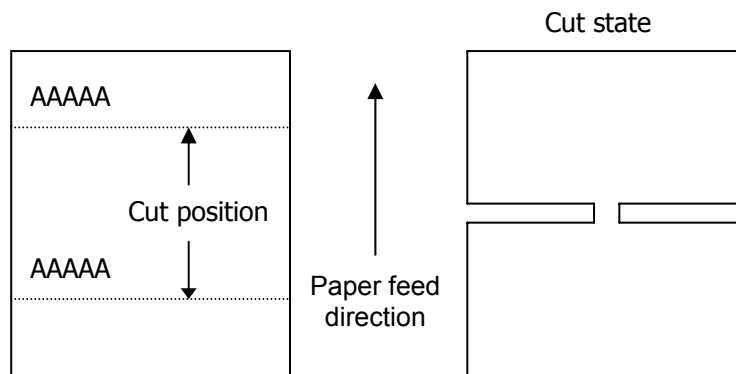

GS V m (1)

GS V m n (2)

[Function] Cutting the paper

[Code] (1) <1D>H<56>H<m>
(2) <1D>H<56>H<m><n>

[Range] (1) $0 \leq m \leq 1$, $48 \leq m \leq 49$
(2) $m = 65, 66$
 $0 \leq n \leq 255$

[Outline] Performs the specified paper cutting.

m	Function
0, 48	Full cut
1, 49	Partial cut (Leaving a bridge area uncut)
65	Paper feed by "cut position + {n x basic calculation pitch}" and full cut
66	Paper feed by "cut position + {n x basic calculation pitch}" and partial cut

[Caution]

- In STANDARD MODE, this command only works when it is entered at the beginning of a line.
- Control to make the length of cut paper less than 10 mm is not executed.

For (1):

- Executes cutting of paper.

For (2):

- If $n = 0$, the paper is fed to the cut position, and then cut. If $n \neq 0$, the paper is fed by "n x basic calculation pitch" inches past the cut position, and then cut.
- The basic calculation pitch is set by GS P.
The paper feed amount is calculated with the vertical basic calculation pitch (y). A fraction resulting from the calculation is corrected with the minimum pitch of the mechanism, and the remainder is omitted.

2.2.11 Bar Code Commands

GS H n

[Function] Selecting of printing position of HRI characters

[Code] <1D>H<48>H<n>

[Range] 0≤n≤3
48≤n≤51

[Outline] Selecting printing position of HRI characters in printing bar codes.
“n” means the followings.

n	Printing Position
0, 48	No printing
1, 49	Above the bar code
2, 50	Below the bar code
3, 51	Both above and below the bar code

The HRI characters refer to the bar code-turned characters so that you can read them.

[Caution]

- The HRI characters are printed in the font selected with GS f.
- Specify before the GS k command.

[Default] n = 0

[See Also] GS f, GS k

[Sample Program]

```
LPRINT CHR$(&H1B);"3"; CHR$(5);
LPRINT CHR$(&H1D);"h"; CHR$(50);
LPRINT CHR$(&H1D);"H"; CHR$(0);
GOSUB BC
LPRINT CHR$(&H1D);"H"; CHR$(1);
GOSUB BC
LPRINT CHR$(&H1D);"H"; CHR$(2);
GOSUB BC
LPRINT CHR$(&H1D);"H"; CHR$(3);
GOSUB BC
END
BC:
LPRINT CHR$(&H1D);"k";
LPRINT CHR$(4);
LPRINT "12"; CHR$(0);
LPRINT CHR$(&HA);
RETURN
```

[Print Results]

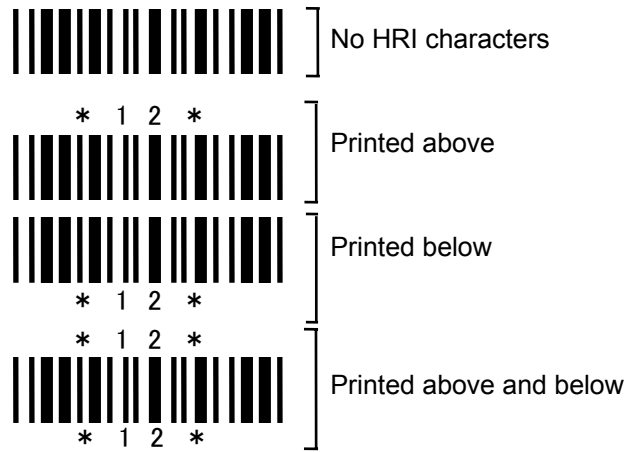

GS f n

[Function] Selecting the font of HRI characters

[Code] <1D>H<66>H<n>

[Range] 0≤n≤2
48≤n≤50

[Outline] Selecting the font of HRI characters in printing bar code.
The type of font can be selected with “n” as follows:

n	Font
0, 48	Font A (12 x 24)
1, 49	Font B (9 x 24)
2, 50	Font C (8 x 16)

The HRI characters refer to the bar code-turned characters so that you can read them.

[Caution] The HRI characters are printed at the position specified with GS H.

[Default] n = 0

[See Also] GS H

[Sample Program]

```
LPRINT CHR$(&H1D);"h"; CHR$(50);
LPRINT CHR$(&H1D);"H"; CHR$(2);
LPRINT CHR$(&H1D);"f"; CHR$(0);
GOSUB BC
LPRINT CHR$(&H1D);"f"; CHR$(1);
GOSUB BC
END
BC:
LPRINT CHR$(&H1D);"k";
LPRINT CHR$(4);
LPRINT "12"; +CHR$(0);
LPRINT CHR$(&HA);
RETURN
```

[Print Results]

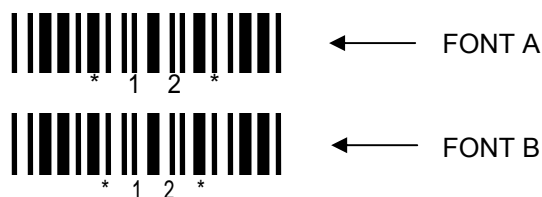

GS h n

[Function]	Specifying the height of the bar code
[Code]	<1D>H<68>H<n>
[Range]	$1 \leq n \leq 255$
[Outline]	Selecting bar code height. “n” denotes the number of dots in the vertical direction.
[Default]	n = 162
[See Also]	GS k, GS w
[Sample Program]	Refer to Sample Program and Print Results for GS w.

GS k m [d1 dk] NULL (1)

GS k m n [d1 dn] (2)

[Function] Printing the bar code

[Code] (1) <1D>H<6B>H<m> [d1.....dk] NULL
(2) <1D>H<6B>H<m><n> [d1....dn]

[Range] (1) $0 \leq m \leq 6$ The definitions of “k” and “d” vary with the bar code system.
(2) $65 \leq m \leq 73$ The definitions of “n” and “d” vary with the bar code system.

[Outline] Selects a bar code system and prints the bar code.

For (1):

m	Bar Code System	Range of “k”	Range of “d”
0	UPC-A	$11 \leq k \leq 12$	$48 \leq d \leq 57$
1	UPC-E	$11 \leq k \leq 12$	$48 \leq d \leq 57$
2	JAN13 (EAN)	$12 \leq k \leq 13$	$48 \leq d \leq 57$
3	JAN8 (EAN)	$7 \leq k \leq 8$	$48 \leq d \leq 57$
4	CODE39	$1 \leq k$	$48 \leq d \leq 57, 65 \leq d \leq 90$ 32, 36, 37, 43, 45, 46, 47
5	ITF	$1 \leq k$ (An even number)	$48 \leq d \leq 57$
6	CODABAR	$1 \leq k$	$48 \leq d \leq 57, 65 \leq d \leq 68$ 36, 43, 45, 46, 47, 58

For (2):

m	Bar Code System	Range of “n”	Range of “d”
65	UPC-A	$11 \leq n \leq 12$	$48 \leq d \leq 57$
66	UPC-E	$11 \leq n \leq 12$	$48 \leq d \leq 57$
67	JAN13 (EAN)	$12 \leq n \leq 13$	$48 \leq d \leq 57$
68	JAN8 (EAN)	$7 \leq n \leq 8$	$48 \leq d \leq 57$
69	CODE39	$1 \leq n \leq 255$	$48 \leq d \leq 57, 65 \leq d \leq 90$ 32, 36, 37, 43, 45, 46, 47
70	ITF	$1 \leq n \leq 255$ (An even number)	$48 \leq d \leq 57$
71	CODABAR	$1 \leq n \leq 255$	$48 \leq d \leq 57, 65 \leq d \leq 68$ 36, 43, 45, 46, 47, 58
72	CODE93	$1 \leq n \leq 255$	$0 \leq d \leq 127$
73	CODE128	$2 \leq n \leq 255$	$0 \leq d \leq 127$

[Caution]

For (1):

- This command ends with a NULL code.
- For UPC-A or UPC-E, the bar code is printed when 12 bytes of bar code data have been entered, and the subsequent data is handled as normal data.
- For JAN13, the bar code is printed when 13 bytes of bar code data have been entered, and the subsequent data is handled as normal data.
- For JAN8, the bar code is printed when 8 bytes of bar code data have been entered, and the subsequent data is handled as normal data.
- The data of ITF bar code must have an even number of columns. Should the data have an odd number of columns, the last column is ignored.

For (2):

- Numeral “n” indicates the number of data items, and the subsequent “n” bytes of data are handled as bar code data.
- If “n” is out of the range, the processing of the command is aborted, and the subsequent data is handled as normal data.

For STANDARD MODE:

- If “d” is out of the range, only a paper feed is executed, and the subsequent data is handled as normal data.
- If the bar code is wider than the print area for one line, the bar code is not printed, but only a paper feed is executed.
- The amount of paper feed corresponds to the height of the bar code (including the HRI characters if HRI character printing is specified), irrespective of the line feed width set by a command such as ESC 2 or ESC 3.
- This command only works if no data exists in the print buffer. If any data exists in the print buffer, the data subsequent to “m” is handled as normal data.
- After the bar code is printed, the beginning of the line is taken as the start position for the next print.
- This command is not affected by any print modes (emphasis, double strike, underline, and character size), except for the inverted character mode.

For PAGE MODE:

- This command only maps the bar code, without performing a printout. After the bar code is mapped, the dot next to the last data item of the bar code is taken as the start position for the next data mapping.
- If “d” is out of the range, the processing of the command is aborted, and the subsequent data is handled as normal data. In this case, the data mapping start position does not move.
- If the bar code is wider than the print area, the bar code is not printed, but the data mapping start position is moved to the left end of the non-print area.

[Description of Bar Codes]

- UPC-A** This bar code, consisting of numerals only, has a fixed length of 12 columns; a 11-column number entered from the host or application software plus a check digit (12th column) automatically calculated inside the printer. If the 12th-column numeral is sent from the host, the entire bar code will be printed as it is.
- UPC-E** This bar code, consisting of numerals only, has a fixed length of 8 columns; the first number system character is "0" stationary. A 12-column numeral entered from the host or application software is compressed to 8 columns with a check digit attached and then is printed. The 12th-column check digit is automatically calculated inside the printer. If it is and sent from the host, the entire bar code will be printed, compressed to 8 columns.
- JAN-13(EAN)** This bar code, consisting of numerals only, has a fixed length of 13 columns; a 12-column number entered from the host or application software plus a check digit (13th column) automatically calculated inside the printer. If the 13th-column numeral is sent from the host, the entire bar code will be printed as it is.
- JAN-8(EAN)** This bar code, consisting of numerals only, has a fixed length of 8 columns; a 7-column number entered from the host or application software plus a check digit (8th column) automatically calculated inside the printer. If the 8th-column numeral is sent from the host, the entire bar code will be printed as it is.
- CODE39** This bar code, consisting of upper-case alphabetic characters and numerals, has a variable length of columns. The start/stop code "*" is automatically added by the printer. The available characters include space and "\$ % * + - . / 0 1 2 3 4 5 6 7 8 9" and upper-case alphabetic characters.
- ITF** This bar code, consisting of only numerals, has a variable length of even-number columns. If a code of odd-number columns is sent, the bar code will not be printed.
- CODABAR (NW-7)** This bar code, consisting of alphanumeric, has a variable length of columns. Available characters include "0 1 2 3 4 5 6 7 8 9 A B C D \$ + - . / :". A start/stop code is required; any one of A, B, C, and D is used.
- CODE93** This bar code, consisting of alphanumeric and control characters, has a variable length of columns. The HRI character string is preceded and followed by a "■" character. HRI characters for control characters (00H - 1FH, and 7FH) are each printed as a combination of a "■" character and an alphabetic character.

Control Character		HRI Character	Control Character		HRI Character
ASCII	Hex.		ASCII	Hex.	
NULL	00	▪U	DLE	10	▪P
SOH	01	▪A	DC1	11	▪Q
STX	02	▪B	DC2	12	▪R
ETX	03	▪C	DC3	13	▪S
EOT	04	▪D	DC4	14	▪T
ENQ	05	▪E	NAK	15	▪U
ACK	06	▪F	SYN	16	▪V
BEL	07	▪G	ETB	17	▪W
BS	08	▪H	CAN	18	▪X
HT	09	▪I	EM	19	▪Y
LF	0A	▪J	SUB	1A	▪Z
VT	0B	▪K	ESC	1B	▪A
FF	0C	▪L	FS	1C	▪B
CR	0D	▪M	GS	1D	▪C
SO	0E	▪N	RS	1E	▪D
SI	0F	▪O	US	1F	▪E
			DEL	7F	▪T

CODE128

This bar code consists of 103 bar code characters and three code sets, enabling 128 ASCII code characters to be printed. It has a variable length of columns.

- Code set A ASCII characters 00H - 5FH can be represented.
- Code set B ASCII characters 20H - 7FH can be represented.
- Code set C Two-digit numbers 00 - 99 can each be represented by one character.

In addition to the above characters, special characters are available:

- Shift character (SHIFT)

When used in code set A, one character next to a Shift character is treated as a character of code set B. When used in code set B, one character next to a Shift character is treated as a character of code set A. The Shift character cannot be used in code set C.

- Code set select characters (CODE A, CODE B, CODE C):

The code set following a code set select character is switched to code set A, B, or C.

- Function characters (FNC1, FNC2, FNC3, FNC4):

How the function characters are used depends on each application. In code set C, only FNC1 is available.

When sending print data, note these points:

- (1) Each string of bar code data must begin with a code set select character (CODE A, CODE B, or CODE C), which selects the first code set to use.
- (2) Every special character is specified by a combination of two characters: a brace "{" followed by one character. A brace "{" itself is sent twice consecutively.

Special characters

Hex.	ASCII	Code Set A	Code Set B	Code Set C
7B53	{ S	SHIFT	SHIFT	-N/A
7B41	{ A	-N/A	CODE A	CODE A
7B42	{ B	CODE B	-N/A	CODE B
7B43	{ C	CODE C	CODE C	-N/A
7B31	{ 1	FNC1	FNC1	FNC1
7B32	{ 2	FNC2	FNC2	-N/A
7B33	{ 3	FNC3	FNC3	-N/A
7B34	{ 4	FNC4	FNC4	-N/A
7B7B	{{	'{'	'{'	'{'

<Example>

To print "No." in code set B, followed by "123456" in code set C, send the following data string:

GS k <73> <10> <7B>H <42>H, "No." <7B>H <43>H <12> <34> <56>

- If the printer finds a string of bar code data that does not begin with a code set select character, it immediately aborts the command processing and handles the subsequent data as normal data.
- If the printer received a character that is not available in the currently selected code set, it immediately aborts the command processing and handles the subsequent data as normal data.
- An HRI character corresponding to either a Shift character or a code select character is not printed. An HRI character for either a function character or a control character is treated as a space character.

[Sample Program]

```
LPRINT CHR$(&H1D);"H"; CHR$(2);
LPRINT CHR$(&H1D);"k";
LPRINT CHR$(4);
LPRINT "123"; CHR$(0);
```









[Print Results]



When the data "123" is printed with the code 39

[Bar Code Print Example]

UPC-A, UPC-E, JAN-13 (EAN), JAN-8 (EAN), CODE39, ITF, CODABAR, CODE93, CODE128

Type	Print Sample	Outline of Symbol
UPC-A		12-column fixed-length bar code consisting of numerals only.
UPC-E		8-column fixed-length bar code consisting of numerals only. Abbreviated version of UPC-A.
JAN-13		13-column fixed-length bar code consisting of numerals only.
JAN-8		8-column fixed-length bar code consisting of numerals only.
CODE39		Variable-length bar code consisting of alphabetic characters and numerals. The start/stop code "*" is automatically added.
ITF		Even-column variable-length bar code consisting of numerals only.
CODABAR (NW-7)		Variable-length bar code consisting of alphanumeric characters. Any one of A, B, C, and D is required as the start/stop code.
CODE93		Variable-length bar code consisting of alphanumeric and control characters.
CODE128		Variable-length bar code consisting of any of 128 ASCII code characters.

Printing is done according to bar code type, number of print columns, bar code height, width (magnification), availability of HRI character, and bar code data.

GS w n

[Function] Specifying the horizontal size (magnification) of bar code

[Code] <1D>H<77>H<n>

[Range] $2 \leq n \leq 6$

[Outline] Selecting bar code width.

[Default] $n = 3$

[Sample Program]

```
LPRINT CHR$(&H1D);"h"; CHR$(30);
LPRINT CHR$(&H1D);"w"; CHR$(2);
GOSUB BC
LPRINT CHR$(&H1D);"h"; CHR$(50);
LPRINT CHR$(&H1D);"w"; CHR$(3);
GOSUB BC
LPRINT CHR$(&H1D);"h"; CHR$(80);
LPRINT CHR$(&H1D);"w"; CHR$(4);
GOSUB BC
END
BC:
LPRINT CHR$(&H1D);"k";
LPRINT CHR$(4);
LPRINT "12"; CHR$(0);
RETURN
```

[Print Results]

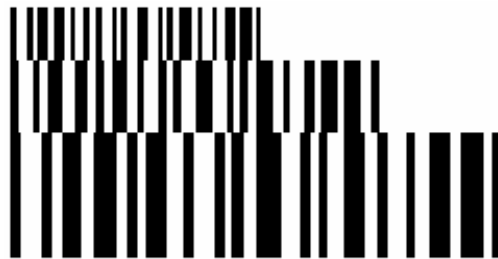

← Height = 30, Magnification = 2

← Height = 50, Magnification = 3

← Height = 80, Magnification = 4

2.2.12 Commands for Non-volatile Memory

FS p n m

[Function] Printing the download NV bit images

[Code] <1C>H<70>H<n><m>

[Range] $1 \leq n \leq 255$
 $0 \leq m \leq 3, 48 \leq m \leq 51$

[Outline] This command prints the download NV bit images (n) using a specified mode (m).
• “n” denotes the number of the download bit image.
• “m” denotes the bit image mode.

m	Mode Name	Dot Density in Vertical Direction	Dot Density in Horizontal Direction
0, 48	NORMAL MODE	203 DPI	203 DPI
1, 49	DOUBLE WIDTH MODE	203 DPI	101 DPI
2, 50	DOUBLE HEIGHT MODE	101 DPI	203 DPI
3, 51	QUADRUPLE SIZE MODE	101 DPI	101 DPI

[Caution]

- The download NV bit image refers to the image that is defined by the FS q command in the non-volatile memory and printed by the FS p command.
- When the specified NV bit image “n” is undefined, this command is invalid.
- When the STANDARD MODE is selected, this command is valid only when there is no data in the print buffer.
- This command is invalid when PAGE MODE is selected.
- Any printing modes except the upside-down printing mode (i.e. emphasis, double strike, underlining, character size, inverted character printing, 90°-right-turned) are not affected.
- When the printing area set by the functions GS L and GS W is not enough for one vertical line of the download NV bit image, the line alone is dealt with as follows. One vertical line of the bit image is 1 dot in NORMAL MODE (m = 0, 48) and DOUBLE HEIGHT MODE (m = 2, 50), and it is 2 dots in double WIDTH MODE (m = 1, 49) and QUADRUPLE SIZE MODE (m = 3, 51).
 - (1) The printing area is extended to the right side within the limits of the printing area so that one vertical line of the download NV bit image can be printed.
 - (2) When a sufficient printing area cannot be maintained even after executing (1), the printing area is extended to the left side. (The left margin is reduced.)
- When the size of a bit image exceeds the limits of the printing area, the data within the limits of the printing area will be printed but the parts exceeding the limit will not be printed.
- Regardless of the amount of line feed set with ESC 2 and ESC 3, NORMAL MODE and DOUBLE WIDTH MODE execute a paper feed of (height “n” of NV bit image) dots while DOUBLE HEIGHT MODE and QUADRUPLE SIZE MODE execute a paper feed of (height “n” of NV bit image x2) dots.
- At the completion of the bit image printing, the head of the line will be used for the next printing position and normal data processing will take place.

[See Also] ESC *, FS q, GS l, GS v 0

FS q n [xL xH yL yH d1...dk] 1... [xL xH yL yH d1...dk] n

[Function] Defining the download NV bit image

[Code]

<1C>H<71>H<n>[<xL><xH><yL><yH><d1...dk>]1 ... [<xL><xH><yL><yH><d1...dk>]n

[Range]

$1 \leq n \leq 255$, $0 \leq xL \leq 255$,
 $0 \leq xH \leq 3$ but, $1 \leq (xL + xH \times 256) \leq 1023$
 $0 \leq yL \leq 255$
 $0 \leq yH \leq 1$ but, $1 \leq (yL + yH \times 256) \leq 288$
 $0 \leq d \leq 255$
 $k = (xL + xH \times 256) \times (yL + yH \times 256) \times 8$
Total definition area = 2M bits (256K bytes)

[Outline]

This command defines the specified NV bit image.

- “n” denotes the number of bit images to be defined.
- xL and xH denote the horizontal size of one NV bit image as $(xL + xH \times 256) \times 8$ dots.
- yL and yH denote the vertical size of one NV bit image as $(yL + yH \times 256) \times 8$ dots.

[Caution]

- Because all the NV bit images previously defined by this command are deleted, it is not possible to redefine any one of the previously defined multiple data. All the data must be resent.
- From the execution of this command until the completion of the hardware reset, any mechanical operation such as opening the cover, initializing the printer head position, or using the paper-feed switch etc.
- The NV bit image refers to a bit image that is defined by the FS q command in the non-volatile memory and printed by the FS p command.
- When the STANDARD MODE is selected, this command is only valid when it is written at the head of a line.
- This command is invalid when PAGE MODE is selected.
- This command becomes valid after the 7 bytes of <FS q n xL xH yL yH> are processed as normal values.
- When data which exceeds the remaining capacity of the defined area is specified by xL, xH, yL, yH, outside-defined-area arguments will be processed.
- When outside-defined-area arguments are processed for the first bit image data group, this command becomes invalid.
- If outside-defined-area arguments are processed for the second or subsequent NV bit image data groups, the processing of this command is suspended, and a writing process into the non-volatile memory starts. At this time, the NV bit image being defined becomes invalid (Undefined), but the preceding NV bit images are valid.
- “d” denotes the definition data. Bits which correspond to dots to be printed are represented as “1”, and those not to be printed as “0”.
- The definition will start from NV bit image number 01H and n-number bit images will be defined in ascending order. Therefore, the first data group [xL xH yL yH d1... dk] becomes NV bit image number 01H, and the last data group [xL xH yL yH d1... dk] becomes NV bit image number 0nH. These numbers of NV bit images coincide with those specified with FS p.
- The definition data of one NV bit image consists of [xL xH yL yH d1... dk]. Therefore, when only one NV bit image is defined, $n = 1$; the data group [xL xH yL yH d1... dk] is manipulated once, and $([Data: (xL + xH \times 256) \times (yL + yH \times 256) \times 8] + [Header: 4])$ bytes of non-volatile memory is used to store it.

- The maximum definition area of this printer is 2M bits (256K bytes). Multiple NV bit images can be defined, but bit images of which total size (Bit image data + Header) exceeds 2M bits (256K bytes) can not be defined.
- The printer state will change to BUSY just before the writing operation into the non-volatile memory begins. Also, for a printer that have a dip switch [BUSY], the printer state will change to BUSY just before the writing operation begins regardless of the state of the dip switch.
- While this command is being executed, it is not possible to send ASB status or to detect the printer status even when the ASB function is selected.
- If this command is sent while a macro is still being defined, the definition process will be stopped and the execution of this command will start.
- NV bit images that are defined already are not initialized by using ESC @ command, or by resetting the printer or turning the power off.
- The command only executes definition of NV bit image, but not start printing. The printing of NV bit image will be executed by FS p.
- Because frequent writing in the non-volatile memory can destroy the memory, the writing command should be used less than 10 times a day.
- It may happen that the printer becomes BUSY during the process of writing data into the non-volatile memory in the execution of this command. When the printer becomes BUSY, it will stop receiving data. Therefore, sending data from the host (including real time command) is prohibited.

[See Also]

FS p

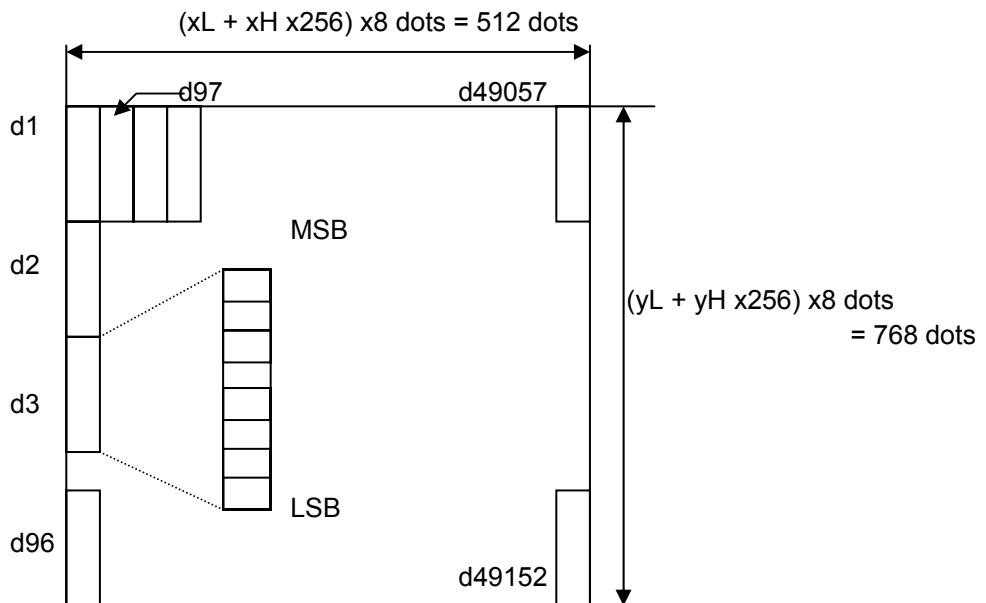

[Example]

When $xL = 64$, $xH = 0$, $yL = 96$, $yH = 0$

2.2.13 Printer Function Setting Commands

GS (E pL pH fn [···]

[Function] Printer function setting command

[Outline] Printer function setting command is a command to change the function of the printer stored on the non-volatile memory and executes the function set by the value of "fn".

Function No. (fn)	Function
1	Transfers to printer function setting mode. (Note)
2	Terminates printer function setting mode. (Note)
3	Sets memory switch value. (Note)
4	Sends memory switch value set.
5	Sets customize value. (Note)
6	Sends customized value set.
7	Copies user-defined page.
8	Defines the data in column format to the character code page of work area.
9	Defines the data in raster format to the character code page of work area.
10	Erases the data of character code page of work area.
11	Sets the communication condition of serial interface. (Note)
12	Sends the communication condition of serial interface set.
255	Sets all contents set in printer function setting mode to the state at the time of shipment.

- pL, pH set the number of bytes following "fn" to (pL + pH x256).
- At the end of printer function setting mode (Function 2), resetting is executed. Then the input buffer is cleared to return various kinds of setting to the state at the time of power on.
- The set value can be confirmed without transferring to printer function setting mode by functions 4, 6, and 12.
- Other functions do not operate without transferring to printer function setting mode.

[Caution]

- This command allows writing to non-volatile memory. Therefore, using this command frequently may result in breakage of memory. Use this command appropriately [10 times max./day].
- During execution of this command, the printer is in Busy state and stops receiving operation. Therefore, data transmission from the host is prohibited.

fn = 1: Function 1 Transferring to Printer Function Setting Mode

GS (E pL pH fn d1 d2 fn = 1

[Code] <1d>H<28>H<45>H pL pH fn d1 d2

[Range] (pL + pH x256) = 3 (pL = 3, pH = 0)
fn = 1
d1 = 73 ("I")
d2 = 78 ("N")

[Outline] Transfers to printer function setting mode and sends the report of mode transfer.

	Hex.	No. of Data
Header	37H	1
ID	20H	1
NULL	00H	1

fn = 2: Function 2 End of Printer Function Setting Mode

GS (E pL pH fn d1 d2 d3 fn = 2

[Code] <1d>H<28>H<45>H pL pH fn d1 d2 d3

[Range] (pL + pH x256) = 4 (pL = 4, pH = 0)
fn = 2
d1 = 79 ("O")
d2 = 85 ("U")
d3 = 84 ("T")

[Outline]

- Terminates printer function setting mode and executes resetting.
Clears input buffer and print buffer and restores various kinds of setting to the state at power on.
- Operates only in printer function setting mode.

fn = 3: Function 3 Setting Memory Switch Value

GS (E pL pH fn [a1 b18 ...b11] ...[ak bk8 ...bk1] fn = 3

[Code] <1d>H<28>H<45>H pL pH fn[a1 b18...b11]...[ak bk8...bk1]

[Range] $10 \leq (pL + pH \times 256) \leq 65535$
 fn = 3
 a = 1, 2, 3
 b = 48, 49, 50

[Outline] • Changes the memory switch set in a to the value set in “b”.

b	Function
48	Sets corresponding bit to OFF.
49	Sets corresponding bit to ON.
50	Does not change corresponding bit.

• Setting memory with 1 (a = 1)

n	b (Set Value)	Function
1	48 (Default)	Reports the power on.
	49	Does not report power on.
2	48 (Default)	Sets input buffer capacity to 4K bytes.
	49	Sets input buffer capacity to 45 bytes.
3	48 (Default)	Sets input buffer full and offline to be Busy.
	49	Sets to be busy with input buffer full.
4	48 (Default)	At the occurrence of receiving error, replaces the data with “?”.
	49	At the occurrence of receiving error, ignores the data.
5	48 (Default)	Disables CR (0DH).
	49	Enables CR (0DH).
6	48 (Default)	Reserved
7	48 (Default)	Does not reset at serial I/F pin 6.
	49	Resets at serial I/F pin 6.
8	48 (Default)	Reserved

- Setting memory switch 2 (a = 2)

n	b (Set Value)	Function
1	49 (Default)	Reserved
2	49 (Default)	Reserved
3	48 (Default)	Disables stored printing.
	49	Enables stored printing.
4	48 (Default)	Line feed immediately at full column width printing
	49	Wait for data at full column width printing
5	48 (Default)	After head-down and PE recovery, prints as it is.
	49	After head-down and PE recovery, prints from the beginning using PAGE MODE, barcode, image, double-height printing, etc. as a unit.
6	49 (Default)	Reserved
7	48 (Default)	Reserved
8	48 (Default)	Reserved

- Setting memory switch 3 (a = 3)

n	b (Set Value)	Function
1	48 (Default)	After clearing cutter error, can be restored by LF-SW signal.
	49	After clearing cutter error, cannot be restored by LF-SW signal.
2	48 (Default)	Reserved
3	48 (Default)	Resets with Reset signal.
	49	Does not reset with Reset signal.
4	48 (Default)	Reserved
5	48 (Default)	Reserved
6	48 (Default)	Reserved
7	48 (Default)	Reserved
8	48 (Default)	Printer automatically clears error when it detects head-down.
	49	Printer clears error when it receives a command <DLE+ENQ> after detecting head-down.

fn = 4: Function 4 Sending the Set Memory Switch Value

GS (E pL pH fn a fn = 4)

[Code] <1d>H<28>H<45>H pL pH fn a

[Range] (pL + pH x256) = 2
fn = 4
a = 1, 2, 3

[Outline] • Sends the content of memory switch set in “a”.

	Hex.	No. of Data
Header	37H	1
ID	21H	1
Data	30H or 31H	8
NULL	00H	1

• Sends the set value of data in 8-byte data raw in order of bits 8, 7, 6,
OFF: 30H (“0”)
ON : 31H (“1”)

fn = 5: Function 5 Setting Customized Value

GS (E pL pH fn [a1 n1L n1H]...[ak nkL nkH] fn = 5

[Code] <1d>H<28>H<45>H pL pH fn [a1 n1L n1H]...[ak nkL nkH]

[Range] 4≤(pL + pH x256) 65535
 fn = 5
 a = 5, 6, 201, 202
 1≤(nL + nH x256) ≤65535

[Default] Described in the processing table for “a”.

[Outline] • Sets the customized value set in “a” to (nL + nH x256).

a	Function
5	Selects printing density.
6	Selects printing speed.
201	Sets ACK output position (only parallel I/F).
202	Selects input buffer full Busy output/cancel timing (idle capacity).

• a = 5: Sets printing density to the level specified by (nL + nH x256).

(nL + nH x256)	Printing Density
65530	70%
65531	75%
65532	80%
65533	85%
65534	90%
65535	95%
0 (Default)	100%
1	105%
2	110%
3	115%
4	120%
5	125%
6	130%
7	135%
8	140%

- a = 6: Sets printing speed to the value specified by (nL + nH x256).

(nL + nH x256)	Printing Speed
1	Printing speed level 1 (84%)
2	Printing speed level 2 (86%)
3	Printing speed level 3 (88%)
4	Printing speed level 4 (90%)
5	Printing speed level 5 (92%)
6	Printing speed level 6 (94%)
7	Printing speed level 7 (96%)
8	Printing speed level 8 (98%)
9 (Default)	Printing speed level 9 (100%)

- a = 201: Outputs ACK to the position specified by (nL + nH x256).

(nL + nH x256)	ACK Output Position
1 (Default)	ACK-in-Busy
2	ACK-while-Busy
3	ACK-after-Busy

- a = 202: Controls input buffer full Busy with the value selected by (nL + nH x256) and controls Busy with output/cancel timing (remaining capacity).

(nL + nH x256)	When Input Buffer Capacity "Small" is Set		When Input Buffer Capacity 4K Bytes (Large) is Set	
	Output	Cancel	Output	Cancel
1	16	26	128	256
2	16	40	128	512
3	30	50	72	256
4	30	60	72	512

- XON/XOFF is also output by the establishment of conditions.
- Ignores the data received when input buffer idle capacity is 0.
- This function operates only in printer function setting mode.
- The value changed by this command is enabled by the following.
- Execution of function 2 (fn = 2: End of printer function setting mode) (Recommended)
- Reentering power supply.
- Hardware resetting by reset terminal

fn = 6: Function 6 Sending the Set Customized Value

GS (E pL pH fn a fn = 6

[Code] <1d>H<28>H<45>H pL pH fn a

[Range] (pL + pH x256) = 2 : (pL = 2, pH = 0)
fn = 6
a = 5, 6, 201, 202

[Outline] • Sends the set value of customized value set by “a”.

	Hex.	No. of Data
Header	37H	1
ID	27H	1
Customized value No.	30H ~ 39H	1 ~ 3
Separation number	1FH	1
Customized value	30H ~ 39H	1 ~ 5
NULL	00H	1

• Configuration of customized value No.

a	Sending Data		
	1st Byte	2nd Byte	3rd Byte
5	53 (“5”)	—	—
6	54 (“6”)	—	—
201	50 (“2”)	48 (“0”)	49 (“1”)
202	50 (“2”)	48 (“0”)	50 (“2”)

• a = 5: When print density is specified

Setting Status		Sending Data				
Stored Value	Print Density	1st Byte	2nd Byte	3rd Byte	4th Byte	5th Byte
65530	70%	54 (“6”)	53 (“5”)	53 (“5”)	51 (“3”)	48 (“0”)
65531	75%	54 (“6”)	53 (“5”)	53 (“5”)	51 (“3”)	49 (“1”)
65532	80%	54 (“6”)	53 (“5”)	53 (“5”)	51 (“3”)	50 (“2”)
65533	85%	54 (“6”)	53 (“5”)	53 (“5”)	51 (“3”)	51 (“3”)
65534	90%	54 (“6”)	53 (“5”)	53 (“5”)	51 (“3”)	52 (“4”)
65535	95%	54 (“6”)	53 (“5”)	53 (“5”)	51 (“3”)	53 (“5”)
0	Basic density	48 (“0”)	—	—	—	—
1	105%	49 (“1”)	—	—	—	—
2	110%	50 (“2”)	—	—	—	—
3	115%	51 (“3”)	—	—	—	—
4	120%	52 (“4”)	—	—	—	—
5	125%	53 (“5”)	—	—	—	—
6	130%	54 (“6”)	—	—	—	—
7	135%	55 (“7”)	—	—	—	—
8	140%	56 (“8”)	—	—	—	—

- a = 6: When printing speed is specified

Setting Status		Sending Data				
Stored Value	Print Density	1st Byte	2nd Byte	3rd Byte	4th Byte	5th Byte
1	Speed level 1	49 ("1")	—	—	—	—
2	Speed level 2	50 ("2")	—	—	—	—
3	Speed level 3	51 ("3")	—	—	—	—
4	Speed level 4	52 ("4")	—	—	—	—
5	Speed level 5	53 ("5")	—	—	—	—
6	Speed level 6	54 ("6")	—	—	—	—
7	Speed level 7	55 ("7")	—	—	—	—
8	Speed level 8	56 ("8")	—	—	—	—
9	Speed level 9	57 ("9")	—	—	—	—

- a = 201: When ACK output position is specified

Setting Status		Sending Data				
Stored Value	ACK Output Position	1st Byte	2nd Byte	3rd Byte	4th Byte	5th Byte
1	ACK-in-Busy	49 ("1")	—	—	—	—
2	ACK-while-Busy	50 ("2")	—	—	—	—
3	ACK-after- Busy	51 ("3")	—	—	—	—

- a = 202: Input buffer full Busy output/cancel timing

At 45 Byte setting (At MSW1-2 ON setting)

Setting Status		Sending Data				
Stored Value	BUSY Output/Cancel	1st Byte	2nd Byte	3rd Byte	4th Byte	5th Byte
1	16/26	49 ("1")	—	—	—	—
2	16/36	50 ("2")	—	—	—	—
3	8/26	51 ("3")	—	—	—	—
4	8/36	52 ("4")	—	—	—	—

At 4k Byte setting (At MSW1-2 OFF setting)

Setting Status		Sending Data				
Stored Value	BUSY Output/Cancel	1st Byte	2nd Byte	3rd Byte	4th Byte	5th Byte
1	128/256	49 ("1")	—	—	—	—
2	128/512	50 ("2")	—	—	—	—
3	72/256	51 ("3")	—	—	—	—
4	72/512	52 ("4")	—	—	—	—

fn = 7: Function 7 Copying User-defined Page

GS (E pL pH fn a d1 d2 fn = 7

[Code] <1d>H<28>H<45>H pL pH fn a d1 d2

[Range] (pL + pH x256) = 4: (pL = 4, pH = 0)
fn = 7
a=10, 12, 17

[Outline] • Copies the data of user-defined code page in the font specified by “a”.

a	Font Type
10	Font B: 9 (horizontal) x24 (vertical)
12	Font A: 12 (horizontal) x24 (vertical)
17	Font C: 8 (horizontal) x16 (vertical)

• Configuration of customized value No.

d1	d2	Function
31	30	Loads the character code page data specified by “a” in storage area to work area.
30	31	Saves the character code page data in work area to the storage area of the font specified by “a”.

- Work area: Area where data is initialized by power OFF or resetting (initialize). Operation is made in accordance with the data set in this area.
- Storage area: Area where data is not initialized by power OFF or resetting (initialize).
- User-defined code page: Page 255 (ESC t 255)
- This function operates only in printer function setting mode.

**fn = 8: Function 8 Defining Data by the Column Format to Character Code
Page of Work Area**

GS (E pL pH fn y c1 c2[x d1...d(y × x)]k fn = 8

[Code] <1d>H<28>H<45>H pL pH fn y c1 c2 [x d1..d(y × x)]k

[Range] 5≤(pL + pH x256)≤65535
 fn = 8
 y = 2 (At selection of font C)
 y = 3 (At selection of other than font C)
 128≤c1≤c2≤255
 0≤x≤12 (At selection of font A)
 0≤x≤9 (At selection of font B)
 0≤x≤8 (At selection of font C)
 0≤d≤255
 k = c2 – c1 + 1

[Outline] Defines the data in column format in units of character on the code page in RAM.
 Operates only in printer function setting mode.

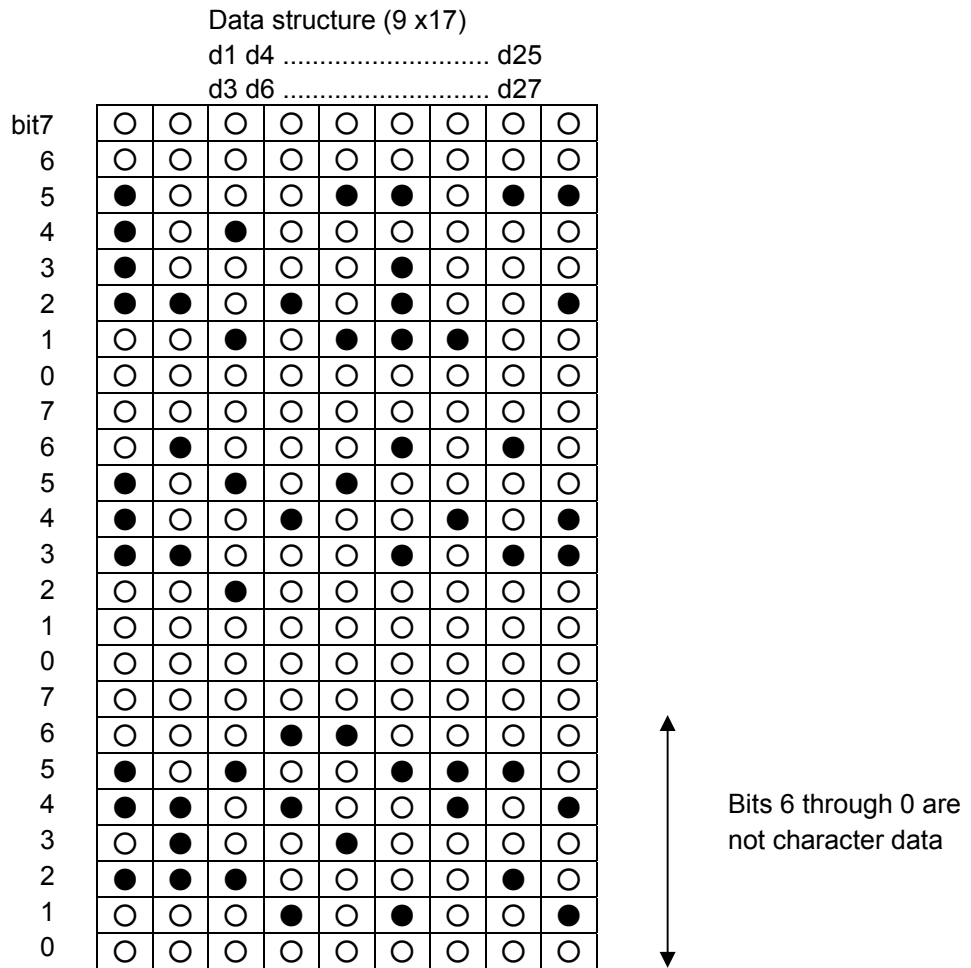

fn = 9: Function 9 Defining Data in the Raster Format to the Character Code Page of Work Area

GS (E pL pH fn x c1 c2[y d1...d(y × x)]k fn = 9

[Code] <1d>H<28>H<45>H pL pH fn x c1 c2 [y d1...d(y × x)]k

[Range] 5≤(pL + pH x256)≤65535
 fn = 9
 y = 1 (At selection of font C) , y = 2 (At selection of other than font C)
 128≤c1≤c2≤255
 0≤x≤24 (At selection of font A)
 0≤x≤24 (At selection of font B)
 0≤x≤16 (At selection of font C)
 0≤d≤255
 k = c2 – c1 + 1

[Outline] Defines the data in raster format in units of character on the character code page in work area.
 Operates only in printer function setting mode.

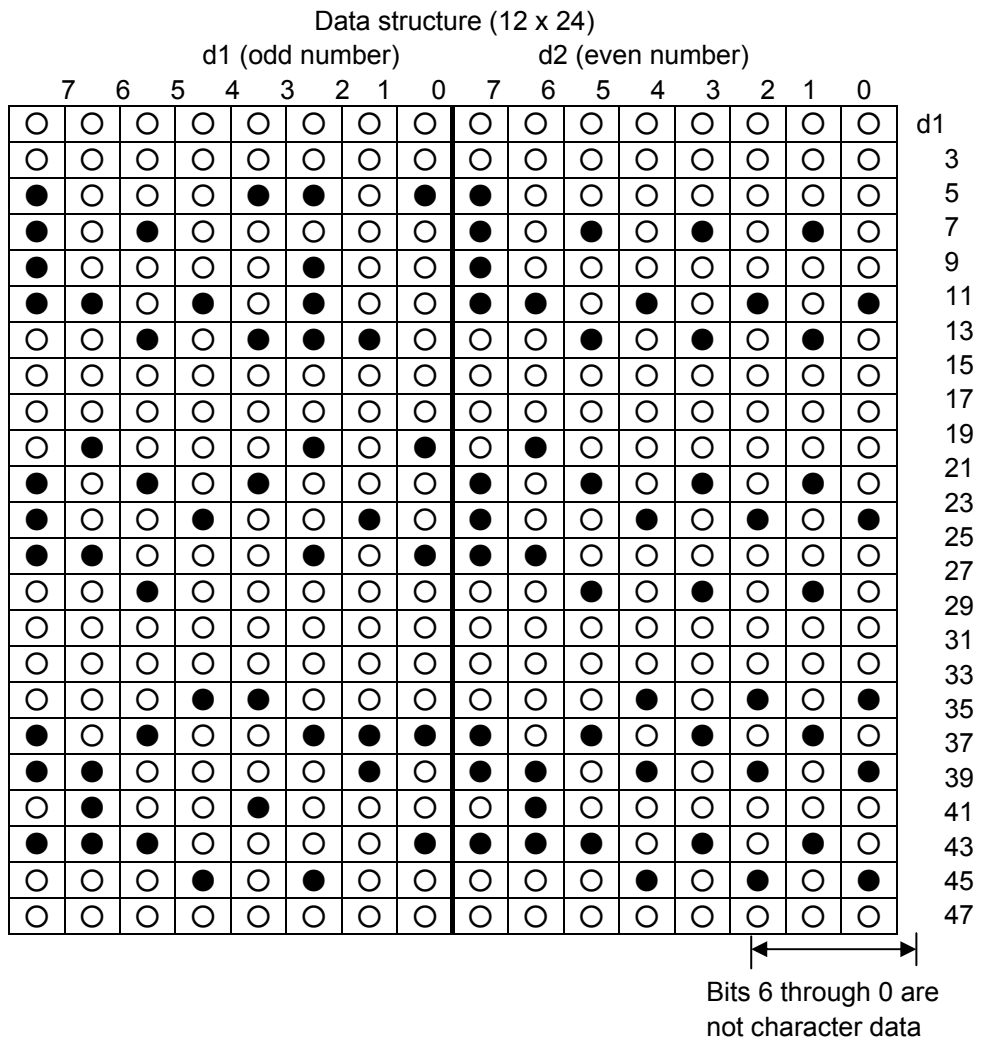

**fn = 10: Function 10 Erasing Data of Character Code Page Data in
Work Area**

GS (E pL pH fn c1 c2 fn = 10)

[Code]	<1d>H<28>H<45>H pL pH fn c1 c2
[Range]	(pL + pH x256) = 3 fn = 10 128≤c1≤c2≤255
[Outline]	Erases (set to space) data in units of character on the character code page in work area. Operates only in printer function setting mode.

fn = 11: Function 11 Setting Communication Conditions of Serial Interface

GS (E pL pH fn a d1...cdk fn = 11

[Code] <1d>H<28>H<45>H pL pH fn a d1..dk

[Range] 3≤(pL + pH x256)≤65535 (0≤pL≤255, 0≤pH≤255)
 fn = 11
 1≤a≤4 (Not changed in other than specified range)
 48≤d≤57 (Not changed in other than specified range)
 1≤k≤6

[Outline] Sets the communication conditions of serial interface specified by "a".

- a = 1: Setting baud rate

Baud Rate	d1	d2	d3	d4	d5	d6
2400	50 ("2")	52 ("4")	48 ("0")	48 ("0")	—	—
4800	52 ("4")	56 ("8")	48 ("0")	48 ("0")	—	—
9600(Default)	57 ("9")	54 ("6")	48 ("0")	48 ("0")	—	—
19200	49 ("1")	57 ("9")	50 ("2")	48 ("0")	48 ("0")	—
38400	51 ("3")	56 ("8")	52 ("4")	48 ("0")	48 ("0")	—

- a = 2: Setting to specified parity

d1	Parity Setting
48 (Default)	No parity
49	Odd parity
50	Even parity

- a = 3: Setting to specified flow control

d1	Flow Control
48 (Default)	DSR/DTR
49	XON/XOFF

- a = 4: Setting to specified data length

d1	Setting Data Length
55	7-bit length
56 (Default)	8-bit length

- Operates only in printer function setting mode.
- Which of dip SW or memory SW is used at initialization depends on "Selecting communication condition setting" of dip SW1-1.

fn = 12: Function 12 Sending the Set Communication Conditions of Serial Interface

GS (E pL pH fn a fn = 12)

[Code] <1d>H<28>H<45>H pL pH fn a

[Range] (pL + pH x256) = 2 (pL = 2, pH = 0)
 fn = 12
 1 ≤ a ≤ 4 (Does not send in other than specified range)

[Outline] Sends communication conditions of serial interface specified by “a”.

	Hex.	No. of Data
Header	37H	1
ID	33H	1
Kind of communication conditions (a)	31H (“1”) ~ 34H (“4”)	1
Separation number	1FH	1
Set value 3	0H ~ 39H	1 ~ 6
NULL	00H	1

Set value

• a = 1: At specification of baud rate

Baud Rate	d1	d2	d3	d4	d5	d6
2400	50 (“2”)	52 (“4”)	48 (“0”)	48 (“0”)	—	—
4800	52 (“4”)	56 (“8”)	48 (“0”)	48 (“0”)	—	—
9600(Default)	57 (“9”)	54 (“6”)	48 (“0”)	48 (“0”)	—	—
19200	49 (“1”)	57 (“9”)	50 (“2”)	48 (“0”)	48 (“0”)	—
38400	51 (“3”)	56 (“8”)	52 (“4”)	48 (“0”)	48 (“0”)	—

• a = 2: At specification of parity

d1	Parity Setting
48	No parity
49	Odd parity
50	Even parity

• a = 3: At specification of flow control

d1	Flow Control
48	DSR/DTR
49	XON/XOFF

• a = 4: Setting to specified data length

d1	Setting Data Length
48	7-bit length
49	8-bit length

**fn = 255: Function 255 Setting All Contents Set by Printer Function
Setting Mode to the State at Shipment**

GS (E pL pH fn a fn = 255)

[Code] <1d>H<28>H<45>H pL pH fn a

[Range] (pL + pH x256) = 2
fn = 255
a = 3, 5, 7, 11, 255

[Outline] Restores various kinds of function set by printer function setting mode to the setting at the time of shipment (initial value described in User's Manual).

a	Function
3	Memory switch
5	Customized value
7	Character code
11	Communication conditions of serial interface
255	Sets all contents set in printer function setting mode to the state at the time of shipment.

GS (K pL pH fn m

[Function] Selecting print control method

[Outline] Executes the setting related to the print control specified by the value of "fn".

Function No. (fn)	Function
49	Sets printing density.
50	Sets printing speed.

fn = 49: Function 49 Setting Printing Density

GS (K pL pH fn m fn = 49)

- [Code]** <1d>H<28>H<4B>H pL pH fn m
- [Range]** (pL + pH x256) = 2 : (pL = 2, pH = 0)
fn = 49
0 ≤ m ≤ 8, 250 ≤ m ≤ 255
- [Default]** m = 0 (Customized value setting value)
- [Outline]** Sets printing density.

m	Printing Density
250	Selects density level -6 (70%)
251	Selects density level -5 (75%)
252	Selects density level -4 (80%)
253	Selects density level -3 (85%)
254	Selects density level -2 (90%)
255	Selects density level -1 (95%)
0	Selects standard density (100%)
1	Selects density level + 1 (105%)
2	Selects density level + 2 (110%)
3	Selects density level + 3 (115%)
4	Selects density level + 4 (120%)
5	Selects density level + 5 (125%)
6	Selects density level + 6 (130%)
7	Selects density level + 7 (135%)
8	Selects density level + 8 (140%)

fn = 50: Function 50 Setting Printing Speed

GS (K pL pH fn m fn = 50)

[Code]	<1d>H<28>H<4B>H pL pH fn m
[Range]	(pL + pH x256) = 2 : (pL = 2, pH = 0) fn = 50 0 ≤ m ≤ 9, 48 ≤ m ≤ 57
[Default]	m = 0 (Customized value setting)
[Outline]	Sets printing speed.

m	Printing Speed
0, 48	Selects print control mode at power on.
1, 49	Selects printing speed level 1.
2, 50	Selects printing speed level 2.
3, 51	Selects printing speed level 3.
4, 52	Selects printing speed level 4.
5, 53	Selects printing speed level 5.
6, 54	Selects printing speed level 6.
7, 55	Selects printing speed level 7.
8, 56	Selects printing speed level 8.
9, 57	Selects printing speed level 9.

GS (M pL pH fn m

[Function] Customizing the printer

[Outline] Executes processing related to escape/recovery of the value set in the work area or the data defined by various kinds of command.

fn	Function
1, 49	Copies the set value stored in work area to the storage area.
2, 50	Copies the set value stored in storage area to the work area.
3, 51	Specifies the auto loading function of the set value at initialization to be valid or invalid.

- Work area:
Area where data is initialized by power OFF of resetting (initialize). Operation is made in accordance with the data set in this area.
- Storage area:
Area where data is not initialized by power OFF or resetting (initialize).

Commands for this function

Command Type	Command
Status relations	ESC c3, GS a
Macro registration	GS :
Character type	ESC M, ESC R, ESC t
Font attribute	ESC !, ESC –, ESC E, ESC G, ESC V, ESC {, GS !, GS B, GS b
Line feed amount, character space	ESC SP, ESC 2, ESC 3
Barcode	GS H, GS f, GS h, GS w
Print position	ESC D, ESC T, ESC a, GS L, GS W
Other	ESC c4, ESC c5, GS P

fn = 1, 49: Function 1 : Copies the set value stored in work area to the storage area

GS (M pL pH fn m fn = 1, 49)

[Code] <1d>H<28>H<4D>H pL pH fn m

[Range] (pL + pH x256) = 2 : (pL = 2, pH = 0)
fn = 1, 49
m = 1, 49

[Outline] Copies the set value stored in work area to the storage area.

[Caution]

- This command allows writing to non-volatile memory. Therefore, using this command frequently may result in breakage of non-volatile memory. Use this command appropriately [10 times max./day].
- During execution of this command, the printer is in Busy state and stops receiving operation. Therefore, data transmission from the host is prohibited.

fn = 2, 50: Function 2 : Copies the set value stored in storage area to the work area

GS (M pL pH fn m fn = 2, 50)

[Code] <1d>H<28>H<4D>H pL pH fn m

[Range] (pL + pH x256) = 2 : (pL = 2, pH = 0)
fn = 2, 50
m = 0, 1, 48, 49

[Outline] Changes the set value of work area by the value of "m".

m	Function
0, 48	Sets all set values of work area to the initial value described in the specification.
1, 49	Copies the set value stored in storage area to the work area. When there is no set value in storage area, sets the value to the initial value described in the specification.

fn = 3, 51: Function 3: Specifies the auto loading function of the set value at initialization to be valid or invalid

GS (M pL pH fn m fn = 3, 51

[Code] <1d>H<28>H<4D>H pL pH fn m

[Range] (pL + pH x256) = 2 : (pL = 2, pH = 0)
fn = 3, 51
m = 0, 1, 48, 49

[Outline] Determines the setting of storage area at initialization to the work area by the value of "m".

m	Function
0, 48	Does not copy data from storage area to work area at initialization.
1, 49	Copies data from storage area to work area at initialization.

2.2.14 Other Commands

DLE ENQ n

[Function] Real-time request to printer

[Code] <10>H<05>H<n>

[Range] $1 \leq n \leq 2$

[Outline] The printer responds in real-time to the request that the host specifies with number "n".

n	Function
0	At the setting of execution of GS ^ by the FEED switch, the same processing as that pressing the FEED switch once is carried out.
1	After recovering from an error, the printer resumes printing from the beginning of the line where the error occurred.
2	The printer clears the receive buffer and the print buffer, and then recovers from the error.

[Caution]

- (n = 1) or (n = 2) shall be used after removing the error.
- When receiving a code row coinciding with the code configuring this command, the same operation as this command takes place and attention by the user is required.
Example: When corresponding code row is present in bit image data.
- This command must not be used between other command code rows.
Example: This command is used in the bit image data.
- This command is ignored during transmission of block data.

[See Also] DLE EOT

DLE DC4 fn d1...d7 (Specification of fn = 8)

[Function] Buffer clear

[Code] <10>H<14>H<fn><d1> ...<d7>

[Range] fn = 8, d1 = 1, d2 = 3, d3 = 20, d4 = 1, d5 = 6, d6 = 2, d7 = 8

[Outline]

- Erases all data in receiving buffer or print buffer.
- Sends the following 3-byte data group.

	Hex.	Decimal	No. of Data
Header	37H	55	1 byte
Identifier	25H	37	1 byte
NULL	00H	0	1 byte

- Enters the state of selecting STANDARD MODE.

[Caution]

- When receiving a code row coinciding with the code configuring this command, the same operation as this command takes place and attention by the user is required.
Example: When corresponding code row is present in bit image data.
- This command must not be used between other command code rows.
Example: This command is used in bit image data.
- This command is ignored during transmission of block data.

[See Also] ESC p

ESC = n

[Function] Data input control

[Code] <1B>H<3D>H<n>

[Range] $0 \leq n \leq 255$

[Outline]

- Selecting equipment for which data input from the host is valid.
- Each bit of “n” indicates as follows.
- When the printer has not been selected, this printer abandons all the received data until it is selected by this command.

Bit	Equipment	Value	
		0	1
0	Printer	Invalid	Valid
1	Not defined	—	—
2	Not defined	—	—
3	Not defined	—	—
4	Not defined	—	—
5	Not defined	—	—
6	Not defined	—	—
7	Not defined	—	—

[Caution]

- Even when the printer has not been selected, it can become BUSY state through printer operation.
- When the printer is deselected, this printer discards all the data until it is selected with this command. (Except DLE EOT, DLE ENQ, and DLE DC4)

[See Also] n = 1

ESC @

- [Function]** Initializing the printer
- [Code]** <1B>H<40>H
- [Outline]** Clears data stored in the print buffer and brings various settings to the initial state (Default state).
- [Caution]**
- The settings of DIP switches are not read again.
 - Data inside the internal input buffer is not cleared.
 - Macro definitions are not cleared.
 - NV bit image definitions are not cleared.
 - Data in the user NV memory is not cleared.

[Sample Program]

```
LPRINT CHR$(&H1B);"!"; CHR$(&H30);  
LPRINT CHR$(&H1B);"V"; CHR$(1);  
LPRINT "AAA"; CHR$(&HA);  
LPRINT CHR$(&H1B);"@";  
LPRINT "AAA"; CHR$(&HA);
```

[Print Results]

▷ ▷ ▷

AAA

Each setting has been initialized by this command.

ESC L

[Function]	Selecting PAGE MODE
[Code]	<1B>H<4C>H
[Outline]	Switches from STANDARD MODE to PAGE MODE.
[Caution]	<ul style="list-style-type: none">• This command is only effective if it entered at the beginning of a line.• This command is not effective if it is entered when in PAGE MODE.• STANDARD MODE is restored when printing specified by FF is finished or when ESC S is issued.• The character mapping start position will be the point specified by ESC T in the print area specified by ESC W.• The commands listed below, which have separate settings for PAGE MODE and STANDARD MODE, are changed to the settings for PAGE MODE use.<ul style="list-style-type: none">(1) Spacing setting: ESC SP, FS S(2) Line feed width setting: ESC 2, ESC 3• The following commands are valid only in PAGE MODE.<ul style="list-style-type: none">(1) ESC V Specifying/canceling 90°-right-turned characters.(2) ESC a Aligning the characters.(3) ESC { Specifying/canceling the inverted characters.(4) GS L Setting the left margin.(5) G3S W Setting the print area width.• The following commands are disabled in PAGE MODE.<ul style="list-style-type: none">(1) GS (A Executes test printing.(2) FS P Prints NV memory bit image.(3) FS q Defines NV memory bit image.(4) GS v 0 Prints raster bit image.• ESC @ restores STANDARD MODE.
[See Also]	Appendix 4.1.4 "Example of using PAGE MODE" FF, CAN, ESC FF, ESC S, ESC T, ESC W, GS W, GS \

ESC S

[Function]	Selecting STANDARD MODE
[Code]	<1B>H<53>H
[Outline]	Switches from PAGE MODE to STANDARD MODE.
[Caution]	<ul style="list-style-type: none">• This command is only effective if it is entered when in PAGE MODE.• Any data mapped in PAGE MODE is erased.• After this command is executed, the beginning of the line is taken as the next print start position.• The print area defined by ESC W is initialized.• The commands listed below, which have separate settings for STANDARD MODE and PAGE MODE, are changed to the settings for STANDARD MODE use.<ul style="list-style-type: none">(1) Spacing setting: ESC SP, FS S(2) Line feed width setting: ESC 2, ESC 3• The following commands are valid only in setting in STANDARD MODE.<ul style="list-style-type: none">(1) ESC W Sets the space amount for setting print area in PAGE MODE.(2) ESC T Selects the printing direction of character in PAGE MODE.(3) GS \$ Sets the absolute position of character vertical direction in PAGE MODE.• STANDARD MODE is selected when the printer is turned on or reset, or when ESC @ is executed.
[See Also]	FF, ESC FF, ESC L

GS (A pL pH n m

[Function] Execution of test printing

[Code] <1D>H<28>H<41>H<pL><pH><n><m>

[Range] (pL + (pH x256)) = 2 (pL = 2, pH = 0)
0 ≤ n ≤ 3, 48 ≤ n ≤ 51
1 ≤ m ≤ 3, 49 ≤ m ≤ 51

[Outline] Specified test printing will be executed.

- pL, pH will specify the number of subsequent parameters by (pL + (pH x256))bytes.
- “n” will specify the paper for test printing in the following table.

n	Category of Paper
0, 48	Basic paper (Paper rolls)
1, 49	Paper rolls
2, 50	
3, 51	

• “m” will specify the category of test printing in the following table.

m	Category of Test Printing
1, 49	Hexadecimal dump
2, 50	Printer’s status printing
3, 51	Memory SW settings

[Caution]

- This command is only valid when processed at the head of a line during the STANDARD MODE.
- The command will be ignored in PAGE MODE.
- During macro definition, if this command is processed, the macro definition is suspended, and the command starts being processed.
- Printer will reset its hard disk after finishing test printing. Therefore, the printer makes download characters, bit map images and macros undefined, clears there caption buffer/print buffer, and returns the various settings to defaults. At this time, the DIP switches are read again.
- Paper cutting is performed at the end of test printing.
- Printer will be BUSY when the processing of the command starts.

GS I n

- [Function]** Sending the printer ID
- [Code]** <1D>H<49>H<n>
- [Range]** 1≤n≤3, 49≤n≤51, 65≤n≤67 n=69,112
- [Outline]** Sends the specified printer ID.

n	Type of Printer ID	Specification	Value (Hex.)
1,49	Model ID	BD2-2220	59
2,50	Type ID	Refer to table "Type ID" below	
3,51	ROM version ID	Differs by ROM version.	

Type ID If n = 2, 50 is specified:

Bit	Meaning	Hex.	Decimal
0	Not equipped for 2 byte code support	00	0
	Equipped for 2 byte code support	01	1
1	Fixed	00	0
2	Reserved	00	0
3	Reserved	00	0
4	Fixed	00	0
5	Reserved	00	0
6	Reserved	00	0
7	Fixed	00	0

Sends the specified printer information.

n	Kind of Printer	Information
65	Firmware version	Differs by firmware version.
66	Manufacturer name	CITIZEN
67	Model name	BD2-2220
69	Kinds of multi-language fonts	Japanese Kanji specifications: KANJI
112	DSW status	Refer to Table [DSW]. * Only serial I/F

	Hex	Data size
Header	5FH	1
Data	20H - 7FH	Differs by printer information
NULL	00H	1

DSW If n = 112 is specified:

Bit	Meaning	Hex.	Decimal
0	DIP switch [DSW5] is OFF.	00	0
	DIP switch [DSW5] is ON.	01	1
1	DIP switch [DSW6] is OFF.	00	0
	DIP switch [DSW6] is ON.	02	2
2	DIP switch [DSW7] is OFF.	00	0
	DIP switch [DSW7] is ON.	04	4
3	DIP switch [DSW8] is OFF.	00	0
	DIP switch [DSW8] is ON.	08	8
4	Reserved	00	0
5	Reserved	00	0
6	Fixed	40	64
7	Fixed	00	0

[Caution]

- Under DTR/DSR control, the printer sends the printer ID after verifying that the host is ready to receive.
- Under XON/XOFF control, the printer sends the printer ID without checking whether or not the host is ready to receive.
- Because this command is executed when data is mapped in the receive buffer, there may be a delay between command receiving and printer ID sending depending on the condition of the receive buffer.
- If ASB (Automatic Status Back) is enabled by GS a, the host must discriminate between the printer ID due to this command and the status due to ASB.

GS P x y

[Function]	Specifying the basic calculation pitch
[Code]	<1D>H<50>H<x><y>
[Range]	$0 \leq x \leq 255$ $0 \leq y \leq 255$
[Outline]	<ul style="list-style-type: none">• This command sets the horizontal basic calculation pitch to approx. 25.4/x mm (1/x inches), and the vertical basic calculation pitch to approx. 25.4/y mm (1/y inches).• If x = 0, the horizontal basic calculation pitch is reverted to the default value.• If y = 0, the vertical basic calculation pitch is reverted to the default value.
[Caution]	<ul style="list-style-type: none">• The horizontal direction is defined as the direction perpendicular to the paper feed, and the vertical direction is defined as the paper feed direction.• In STANDARD MODE, the following parameters are used regardless of the character orientation (e.g. inverted or 90°-right-turned).<ul style="list-style-type: none">(1) Commands using x: ESC SP, ESC \$, ESC \, FS S, GS L, GS W(2) Commands using y: ESC 3, ESC J• In PAGE MODE, the parameters used depend on the character orientation, as follows:<ul style="list-style-type: none">(1) If the start point specified by ESC T is the top left or bottom right (The characters are mapped in the direction perpendicular to the paper feed):<ul style="list-style-type: none">• Commands using x: ESC SP, ESC \$, ESC W, ESC \, FS S• Commands using y: ESC 3, ESC J, ESC W, GS \$, GS \(2) If the start point specified by ESC T is the top right or bottom left (The characters are mapped in the paper feed direction):<ul style="list-style-type: none">• Commands using x: ESC 3, ESC J, ESC W, GS \$, GS \• Commands using y: ESC SP, ESC \$, ESC W, ESC \, FS S• This command does not affect any other values that are already set.• If calculations made in combination with another command generate fractions, the fractions are corrected with the minimum pitch of the mechanism, and the remainder is omitted.
[Default]	x = 203, y = 360
[See Also]	Appendix 4.1 "Explanation on PAGE MODE" ESC SP, ESC \$, ESC 3, ESC J, ESC W, ESC \, GS \$, GS L, GS W, GS

3. CHARACTER CODE TABLE

3.1 Code Page

3.1.1 Codepage 00H to 7FH & PC437 (USA, Europe Standard)

	0	1	2	3	4	5	6	7	8	9	A	B	C	D	E	F
0	NUL	DLE		0	@	P	`	p	Ç	É	á	☒		⊥		
1		XON	!	1	A	Q	a	q	ü	æ	í	☒		⊥		±
2			"	2	B	R	b	r	é	Æ	ó	☒		⊥		
3		XOF F	#	3	C	S	c	s	â	ô	ú			⊥		
4	EOT	DC4	\$	4	D	T	d	t	ä	ö	ñ			⊥		∫
5	ENQ		%	5	E	U	e	u	à	ò	Ñ	†		⊥		∫
6			&	6	F	V	f	v	â	û	ä	†	†	⊥	μ	÷
7			'	7	G	W	g	w	ç	ù	ó	†	†	†		≈
8		CAN	(8	H	X	h	x	ê	ÿ	ı	†	⊥	†		°
9	HT)	9	I	Y	i	y	ë	Ö	ı	†	⊥			
A	LF		*	:	J	Z	j	z	è	Ü	ı		⊥			.
B		ESC	+	;	K	[k	{	ï	ø	½	†	⊥	■		
C	FF	FS	,	<	L	¥	ı		î	&	¼	⊥	†	■		ˆ
D	CR	GS	-	=	M]	m	}	ì	¥	ı	⊥	=	■	∅	²
E		RS	.	>	N	^	n	~	Ä	Pt	«	⊥	†	■		■
F			/	?	O	_	o		Å	f	»		⊥	■		

3.1.2 Codepage 00H to 7FH & Katakana

	0	1	2	3	4	5	6	7	8	9	A	B	C	D	E	F
0	NUL	DLE		0	@	P	`	p	_		SP	-	タ	ミ	=	×
1		XON	!	1	A	Q	a	q	▬		°	ア	チ	ム	ト	円
2			"	2	B	R	b	r	■			イ	ツ	メ	十	年
3		XOF F	#	3	C	S	c	s	■			ウ	テ	モ	十	月
4	EOT	DC4	\$	4	D	T	d	t	■		,	エ	ト	ヤ	▲	日
5	ENQ		%	5	E	U	e	u	■	—	・	オ	ナ	ユ	▲	時
6			&	6	F	V	f	v	■		ヲ	カ	ニ	ヨ	▼	分
7			'	7	G	W	g	w	■		ア	キ	ヌ	ラ	▼	秒
8		CAN	(8	H	X	h	x			イ	ク	ネ	リ	♠	〒
9	HT)	9	I	Y	i	y			ウ	ケ	ノ	ル	♥	市
A	LF		*	:	J	Z	j	z			エ	コ	ハ	レ	◆	区
B		ESC	+	;	K	[k	{	■		オ	サ	ヒ	ロ	♣	町
C	FF	FS	,	<	L	¥	l		■	ゝ	ヤ	シ	フ	ワ		村
D	CR	GS	-	=	M]	m	}	■	ゝ	ユ	ス	ヘ	ン		人
E		RS	.	>	N	^	n	~	■	ゝ	ヨ	セ	ホ	“	/	⋮
F			/	?	O	_	o		+	ゝ	ツ	ソ	マ	°	\	SP

3.1.3 Codepage 00H to 7FH & PC850 (Multilingual)

	0	1	2	3	4	5	6	7	8	9	A	B	C	D	E	F
0	NUL	DLE		0	@	P	`	p	Ç	É	á	☒		ð	Ó	
1		XON	!	1	A	Q	a	q	ü	æ	í	☒		Ð		±
2			"	2	B	R	b	r	é	Æ	ó	☒		Ê	Ô	=
3		XOF F	#	3	C	S	c	s	â	ô	ú			Ë	Ò	¼
4	EOT	DC4	\$	4	D	T	d	t	ä	ö	ñ			È	õ	¶
5	ENQ		%	5	E	U	e	u	à	ò	Ñ	Á		€	Õ	§
6			&	6	F	V	f	v	â	û	ä	Â	ã	í	μ	÷
7			'	7	G	W	g	w	ç	ù	ó	À	Ã	î	þ	↳
8		CAN	(8	H	X	h	x	ê	ÿ	ı	©	ℓ	ï	þ	°
9	HT)	9	I	Y	i	y	ë	ö	®	†	ℓ		Ú	¨
A	LF		*	:	J	Z	j	z	è	Ü	¬		±		Û	·
B		ESC	+	;	K	[k	{	ï	ø	½	¬	±	■	Ù	¹
C	FF	FS	,	<	L	¥	l		î	£	¼	⌋	†	■	Ý	³
D	CR	GS	-	=	M]	m	}	ì	Ø	i	ø	-	ı	Ý	²
E		RS	.	>	N	^	n	~	Ä	×	«	¥	†	ì		■
F			/	?	O	_	o		Å	f	»		☒	■		

3.1.4 Codepage 00H to 7FH & PC860 (Portuguese)

	0	1	2	3	4	5	6	7	8	9	A	B	C	D	E	F
0	NUL	DLE		0	@	P	`	p	Ç	É	á	☒		⊥		
1		XON	!	1	A	Q	a	q	ü	À	í	☒		⊥		±
2			"	2	B	R	b	r	é	È	ó	☒		⊥		
3		XOF F	#	3	C	S	c	s	â	ô	ú			⊥		
4	EOT	DC4	\$	4	D	T	d	t	ã	õ	ñ			⊥		∫
5	ENQ		%	5	E	U	e	u	à	ò	Ñ	†		⊥		∫
6			&	6	F	V	f	v	Á	Ú	<u>a</u>	†	†	⊥	μ	÷
7			'	7	G	W	g	w	ç	ù	<u>o</u>	†	†	†		≈
8		CAN	(8	H	X	h	x	ê	ì	¿	†	⊥	†		°
9	HT)	9	I	Y	i	y	Ê	Õ	Ò	†	⊥			
A	LF		*	:	J	Z	j	z	è	Ü	¬		⊥			.
B		ESC	+	;	K	[k	{	Í	ø	½	†	⊥	■		
C	FF	FS	,	<	L	¥	l		Ô	&	¼	⌋	†	■		"
D	CR	GS	-	=	M]	m	}	ì	Ù	i	⌋	-	■	∅	₂
E		RS	.	>	N	^	n	~	Ã	Pt	«	⌋	†	■		■
F			/	?	O	_	o		Â	Ó	»		⊥	■		

3.1.5 Codepage 00H to 7FH & PC863 (Canadian-French)

	0	1	2	3	4	5	6	7	8	9	A	B	C	D	E	F
0	NUL	DLE		0	@	P	`	p	Ç	É	;	☒		⊥		
1		XON	!	1	A	Q	a	q	ü	È	'	☒		⊥		±
2			"	2	B	R	b	r	é	Ê	ô	☒		⊥		
3		XOF F	#	3	C	S	c	s	â	ô	ú			⊥		
4	EOT	DC4	\$	4	D	T	d	t	Â	Ë	¨			⊥		∫
5	ENQ		%	5	E	U	e	u	à	Ï	>	⊥		⊥		∫
6			&	6	F	V	f	v	¶	û	³	⊥	⊥	⊥	μ	÷
7			'	7	G	W	g	w	ç	ù	-	⊥	⊥	⊥		≈
8		CAN	(8	H	X	h	x	ê	◊	î	⊥	⊥	⊥		◦
9	HT)	9	I	Y	i	y	ë	Ô	⊥	⊥	⊥			
A	LF		*	:	J	Z	j	z	è	Ü	⊥	⊥	⊥			.
B		ESC	+	;	K	[k	{	ï	ø	½	⊥	⊥	■		
C	FF	FS	,	<	L	¥	l		î	&	¼	⊥	⊥	■		ⁿ
D	CR	GS	-	=	M]	m	}	=	Ù	¾	⊥	-	■	∅	²
E		RS	.	>	N	^	n	~	À	Û	«	⊥	⊥	■		■
F			/	?	O	_	o		§	f	»		⊥	■		

3.1.6 Codepage 00H to 7FH & PC865 (Nordic)

	0	1	2	3	4	5	6	7	8	9	A	B	C	D	E	F
0	NUL	DLE		0	@	P	`	p	Ç	É	á	☒		⊥		
1		XON	!	1	A	Q	a	q	ü	æ	í	☒		⊥		±
2			"	2	B	R	b	r	é	Æ	ó	☒		⊥		
3		XOF F	#	3	C	S	c	s	â	ô	ú			⊥		
4	EOT	DC4	\$	4	D	T	d	t	ä	ö	ñ			⊥		∫
5	ENQ		%	5	E	U	e	u	à	ò	Ñ	†		⊥		∫
6			&	6	F	V	f	v	å	û	<u>a</u>	†	†	⊥	μ	÷
7			'	7	G	W	g	w	ç	ù	<u>o</u>	†	†	†		≈
8		CAN	(8	H	X	h	x	ê	ÿ	ı	†	⊥	†		°
9	HT)	9	I	Y	i	y	ë	Ö	†	†	⊥			
A	LF		*	:	J	Z	j	z	è	Ü	†		⊥			.
B		ESC	+	;	K	[k	{	ï	ø	½	†	⊥	■		
C	FF	FS	,	<	L	¥	l		î	£	¼	†	†	■		"
D	CR	GS	-	=	M]	m	}	ì	Ø	i	†	=	■	∅	₂
E		RS	.	>	N	^	n	~	Ä	Pt	«	†	†	■		■
F			/	?	O	_	o		Å	f	α		⊥	■		

3.1.7 Codepage 00H to 7FH & PC852 (Eastern Europe)

	0	1	2	3	4	5	6	7	8	9	A	B	C	D	E	F
0	NUL	DLE		0	@	P	`	p	Ç	É	á	☒		đ	Ó	-
1		XON	!	1	A	Q	a	q	ü	Í	í	☒		Đ		"
2			"	2	B	R	b	r	é	Í	ó	☒		Ď	Ó	`
3		XOF F	#	3	C	S	c	s	â	Ú	ú			Ě	Ń	˘
4	EOT	DC4	\$	4	D	T	d	t	ä	Ö	Ą			ď	Ń	˘
5	ENQ		%	5	E	U	e	u	û	Ĺ	ą	Á		Ń	Ń	§
6			&	6	F	V	f	v	ć	Ŷ	ž	Â	Ă	í	š	÷
7			'	7	G	W	g	w	ç	Ś	ż	Ě	Ă	î	š	↳
8		CAN	(8	H	X	h	x	ł	Ś	Ę	Ş	Ł	ě	Ŕ	°
9	HT)	9	I	Y	i	y	ë	Ö	ę	ł	ł		Ú	¨
A	LF		*	:	J	Z	j	z	ő	Ü	ł		ł		Ŕ	·
B		ESC	+	;	K	[k	{	ó	Ŧ	ż	ł	ł	■	Ű	ű
C	FF	FS	,	<	L	¥	l		î		č	ł	ł	■	Ý	Ř
D	CR	GS	-	=	M]	m	}	ž	Ł	ş	Ż	-	ł	Ý	ř
E		RS	.	>	N	^	n	~	Ä	×	«	Ż	ł	Ű	ł	■
F			/	?	O	_	o		Ć	Č	»		☒	■	'	SP

3.1.8 Codepage 00H to 7FH & PC866 (Russian)

	0	1	2	3	4	5	6	7	8	9	A	B	C	D	E	F
0	NUL	DLE		0	@	P	`	p				⌘		⌞		Ё
1		XON	!	1	A	Q	a	q				⌘		⌞		ё
2			"	2	B	R	b	r				⌘		⌞		Э
3		XOFF	#	3	C	S	c	s						⌞		э
4	EOT	DC4	\$	4	D	T	d	t						⌞		Ї
5	ENQ		%	5	E	U	e	u				⌞		⌞		ї
6			&	6	F	V	f	v				⌞	⌞	⌞		ÿ
7			'	7	G	W	g	w				⌞	⌞	⌞		
8		CAN	(8	H	X	h	x				⌞	⌞	⌞		°
9	HT)	9	I	Y	i	y				⌞	⌞			·
A	LF		*	:	J	Z	j	z				⌞	⌞			·
B		ESC	+	;	K	[k	{				⌞	⌞	■		
C	FF	FS	,	<	L	¥	l					⌞	⌞	■		No
D	CR	GS	-	=	M]	m	}				⌞	⌞	⌞		◊
E		RS	.	>	N	^	n	~				⌞	⌞	Ů		■
F			/	?	O	_	o					⌞	⌞	■		

3.1.9 Codepage 00H to 7FH & PC857 (Turkish)

	0	1	2	3	4	5	6	7	8	9	A	B	C	D	E	F
0	NUL	DLE		0	@	P	`	p	Ç	É	á	☒		o	ó	
1		XON	!	1	A	Q	a	q	ü	æ	í	☒		a		±
2			"	2	B	R	b	r	é	Æ	ó	☒		Ê	ô	
3		XOFF	#	3	C	S	c	s	â	ô	ú			Ë	ò	¾
4	EOT	DC4	\$	4	D	T	d	t	à	ö	ñ			È	õ	¶
5	ENQ		%	5	E	U	e	u	ä	ò	Ñ	Á			Õ	§
6			&	6	F	V	f	v	â	û	Ê	Â	ã	í	µ	÷
7			'	7	G	W	g	w	ç	ù	ê	À	Ã	î		↳
8		CAN	(8	H	X	h	x	ê	í	ı	©	ℒ	ï	×	°
9	HT)	9	I	Y	i	y	ë	Ö	®	†	ℓ		Ú	¨
A	LF		*	:	J	Z	j	z	è	Ü	¬		⊥		Û	.
B		ESC	+	;	K	[k	{	ï	ø	½	⌈	⌋	■	Ù	'
C	FF	FS	,	<	L	¥	l		î	£	¼	⌋	⌈	■	Û	³
D	CR	GS	-	=	M]	m	}	ı	Ø	i	œ	-	ı	ÿ	²
E		RS	.	>	N	^	n	~	Ä	Ş	«	¥	†	ı	-	■
F			/	?	O	_	o		Å	ş	»		⊙	■	'	SP

3.1.10 Codepage 00H to 7FH & PC864 (Arabic)

	0	1	2	3	4	5	6	7	8	9	A	B	C	D	E	F
0	NUL	DLE		0	@	P	`	p	◦	β	(RSP)	•	ϕ	ذ	—	س
1		XON	!	1	A	Q	a	q	•	∞	(SHY)	۱	۶	ر	ف	س
2			“	2	B	R	b	r	•	φ	⌈	۲	آ	ز	ق	ن
3		XOFF	#	3	C	S	c	s	√	±	£	۳	أ	س	ك	ه
4	EOT	DC4	\$	4	D	T	d	t	▒	½	⊗	٤	ؤ	ش	ل	٤
5	ENQ		%	5	E	U	e	u	▒	¼	ل	٥	ح	ط	د	٥
6			&	6	F	V	f	v	▒	≈		٦	ث	ض	ن	٦
7			'	7	G	W	g	w	▒	«		٧	ا	ط	ه	غ
8		CAN	(8	H	X	h	x	▒	»	ا	٨	ب	ظ	و	ق
9	HT)	9	I	Y	i	y	▒	لأ	ب	٩	ة	ع	ى	لأ
A	LF		*	:	J	Z	j	z	▒	لأ	ت	ف	ت	غ	ي	لأ
B		ESC	+	;	K	[k	{	▒		ث	؛	ث	ا	ض	ل
C	FF	FS	,	<	L	\	l		▒		،	س	ج	٦	ع	لك
D	CR	GS	-	=	M]	m	}	▒	لا	ج	ش	ج	÷	غ	ي
E		RS	.	>	N	^	n	~	▒	لا	ح	ص	خ	×	غ	■
F			/	?	O	_	o		▒	،	خ	؟	د	ع	م	

3.1.11 Codepage 00H to 7FH & WPC1252

	0	1	2	3	4	5	6	7	8	9	A	B	C	D	E	F
0	NUL	DLE		0	@	P	`	p	€			°	À	Đ	à	đ
1		XON	!	1	A	Q	a	q		'	i	±	Á	Ñ	á	ñ
2			"	2	B	R	b	r	,	'	ø	²	Â	Ò	â	ò
3		XOF F	#	3	C	S	c	s	f	“	£	³	Ã	Ó	ã	ó
4	EOT	DC4	\$	4	D	T	d	t	,,	”	¤	´	Ä	Ô	ä	ô
5	ENQ		%	5	E	U	e	u	...	·	¥	µ	Å	Õ	å	õ
6			&	6	F	V	f	v			¦	¶	Æ	Ö	æ	ö
7			'	7	G	W	g	w		-	§	·	Ç	×	ç	÷
8		CAN	(8	H	X	h	x		~	¨	,	È	Ø	è	ø
9	HT)	9	I	Y	i	y	‰	™	©	¹	É	Ù	é	ù
A	LF		*	:	J	Z	j	z	Š	š	ª	º	Ê	Ú	ê	ú
B		ESC	+	;	K	[k	{	<	>	«	»	Ë	Û	ë	û
C	FF	FS	,	<	L	¥	l		Œ	œ	¬	¼	Ì	Ü	ì	ü
D	CR	GS	-	=	M]	m	}			-	½	Í	Ý	í	ý
E		RS	.	>	N	^	n	~			®	¾	Î	Þ	î	þ
F			/	?	O	_	o			ÿ	¯	¿	Ï	Ɔ	ï	ÿ

3.1.12 Codepage 00H to 7FH & Thai Code 18

	0	1	2	3	4	5	6	7	8	9	A	B	C	D	E	F
0	NUL	DLE		0	@	P	`	p	Г	๕		ฐ	ภ	๕	ใ	๐
1		XON	!	1	A	Q	a	q	Г	๖	ภ	ท	ม	๖	แ	๑
2			"	2	B	R	b	r	L	๗	ช	ฒ	ย	๗	โ	๒
3		XOFF	#	3	C	S	c	s	J	๘	ช	ณ	ร	๗	ใ	๓
4	EOT	DC4	\$	4	D	T	d	t		๙	ค	ค	ถ	๗	ไ	๔
5	ENO		%	5	E	U	e	u	-	๐+	ค	ค	ฉ	๗	๗	๕
6			&	6	F	V	f	v	+	๑-	ฆ	ถ	ภ	๘	๗	๖
7			'	7	G	W	g	w	+	๑๐	ง	ท	ว	๗	๘	๗
8		CAN	(8	H	X	h	x	⊥	๑๑	จ	ถ	ศ	๑	๑	๘
9	HT)	9	I	Y	i	y	T	๑+	ฉ	น	ช	๑	๑	๙
A	LF		*	:	J	Z	j	z	+	๑๔	ช	บ	ส	๑	๑	๙
B		ESC	+	;	K	[k	{	■	๑-	ช	ป	ท	๑-	+	๑-
C	FF	FS	,	<	L	\	l		←	๑๒	ณ	ผ	พิ	๑๒	๑	๑๒
D	CR	GS	-	=	M]	m	}	↑	๑๓	ณ	ผ	อ	๑๓	๑	๑๓
E		RS	.	>	N	^	n	~	→	๑+	ณ	พ	ฮ	๑+	๑	๑+
F			/	?	O	_	o		↓	๑	ณ	พ	๗	฿	๑	

3.2 International Character Code Table

	Country	23	24	40	5B	5C	5D	5E	60	7B	7C	7D	7E
0	U.S.A	#	\$	@	[\]	^	'	{		}	~
1	France	#	\$	à	°	ç	§	^	'	é	ù	è	¨
2	Germany	#	\$	§	Ä	Ö	Ü	^	'	ä	ö	ü	β
3	U.K.	£	\$	@	[\]	^	'	{		}	~
4	Denmark I	#	\$	@	Æ	Ø	Å	^	'	æ	ø	å	~
5	Sweden	#	□	É	Ä	Ö	Å	Ü	é	ä	ö	å	ü
6	Italy	#	\$	@	°	\	é	^	ù	à	ò	è	ì
7	Spain I	Pt	\$	@	i	Ñ	¿	^	'	¨	ñ	}	~
8	Japan	#	\$	@	[¥]	^	'	{		}	~
9	Norway	#	□	É	Æ	Ø	Å	Ü	é	æ	ø	å	ü
10	Denmark II	#	\$	É	Æ	Ø	Å	Ü	é	æ	ø	å	ü
11	Spain II	#	\$	á	i	Ñ	¿	é	'	ì	ñ	ó	ú
12	Latin America	#	\$	á	i	Ñ	¿	é	ü	ì	ñ	ó	ú
13	Korea	#	\$	@	[₩]	^	'	{		}	~

4. APPENDIX

4.1 Explanation on PAGE MODE

4.1.1 Overview

The printer has two print modes: STANDARD and PAGE.

In STANDARD MODE, the printer prints or feeds paper each time it receives a print or paper feed command. In PAGE MODE, when the printer receives print commands and/or form feed commands, it simply forwards them to the specified print area of memory. Only when an ESC FF or FF is executed, all the data mapped in the print area will then be printed in a batch.

For example, suppose you executed a print and line feed for data "ABCDEF"<LF>. In STANDARD MODE, the data "ABCDEF" is printed and paper is advanced one line. In PAGE MODE, the data "ABCDEF" is written in the specified print area of memory, and the memory location for the storage of the next print data is shifted one line.

The printer enters PAGE MODE with an ESC L, so that all commands received after that point are handled in PAGE MODE. When an ESC FF is executed, the data received until then is printed in a batch. When an FF is executed, the data received until then is printed in a batch, after which the printer returns to STANDARD MODE. An ESC S causes the printer to immediately return to STANDARD MODE; any print data, however, that has been stored in PAGE MODE is not printed. Instead it will be cleared.

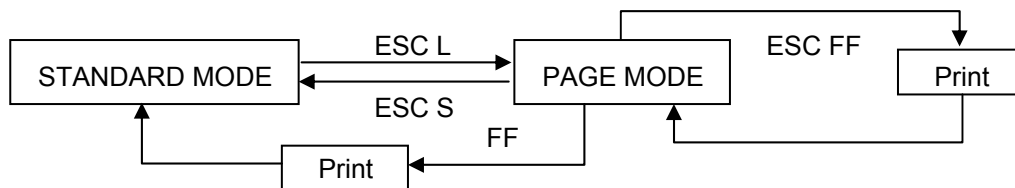

[Switching Between STANDARD MODE and PAGE MODE]

4.1.2 Values Set by Each Command in STANDARD MODE and PAGE MODE

(1) The values set with commands are common to the STANDARD MODE and PAGE MODE. The values set with any of the commands listed below are, however, treated differently and stored separately for the STANDARD and PAGE MODES.

- ESC SP, ESC 2, ESC 3, FS S

(2) The maximum printable size of a bitmap image is 576 dots for STANDARD MODE. In PAGE MODE, the maximum printable size of a bitmap image is 831 dots in the "y" direction (paper feed direction). (However 831 dots are reserved for "y" of the print area set by ESC W and the value of print direction "n" specified by ESC T is 1 or 3.)

4.1.3 Mapping of Print Data in the Print Area

Print data is mapped in the print area as follows:

- (1) The print area is set by ESC W. When the printer has finished all of the print and paper feed actions specified before receiving an ESC W, the ESC W sets the right end (as viewed facing the printer) as the start point (x0, y0) of the print area. The print area is a rectangle defined by two edges extending from the start point (x0, y0): one edge running in the "x" (Horizontal) direction by "dx" pitch (inclusive of the start point), and the other running in the "y" (Vertical) direction by "dy" pitch. (If no ESC W is defined, the default values are used to define the print area.)
- (2) With a print area defined by ESC W and a print direction specified by ESC T, when the printer receives print data, the print data is mapped in the print area where point A (see the Figure 4-1 "Mapping Position for Character Data") is used as the initial value of the start point. If the print data consists of characters, this start point serves as the baseline.

If the print data is a downloaded bitmap image or a bar code, the print data is mapped with its lower-left point B aligned to the baseline. (See the Figure 4-2 "Mapping Positions for Print Data".) When attempting to map the HRI characters of a bar code, however, the section above the standard character height will not be printed.

- (3) If print data (or the space to the right of a character) extends beyond the print area before a command that involves a line feed (for example, LF or ESC J command) is received, a line feed is automatically executed in the print area, so that the mapping position of the print data is moved one line. The next mapping position will be the beginning of the line. In this case, the line feed width is as defined by a command such as ESC 2 or ESC 3.
- (4) By default, the line feed width is 1/6 inch, which is equivalent to 34 dots. If the print data for the next line includes a vertically doubled or taller character, a downloaded bitmap image extending two or more lines, or a bar code taller than the character height, the data, therefore, falls short of the line feed width, causing the upper dots of the character to overlap the print data of the current line. The line feed width needs to be increased.

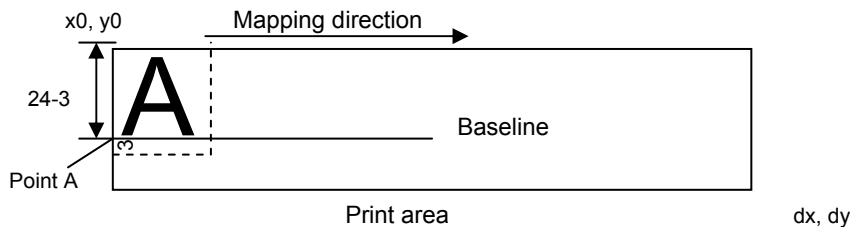

Figure 4-1 Mapping Position for Character Data

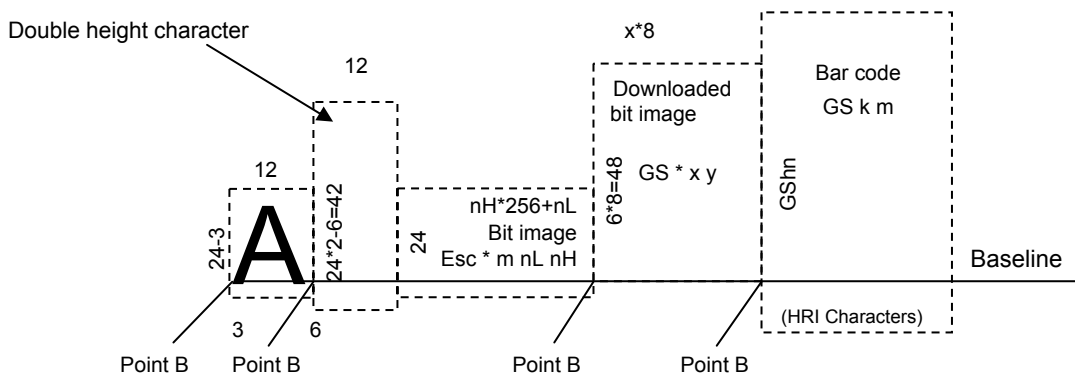

Figure 4-2 Mapping Positions for Print Data

4.1.4 Example of Using PAGE MODE

The following explains specific uses of PAGE MODE.

When in PAGE MODE, the commands are typically sent from the host to the printer in the following sequence:

- (1) An ESC L puts the printer in PAGE MODE.
- (2) An ESC W specifies the print area.
- (3) An ESC T specifies the print direction.
- (4) Print data is sent.
- (5) An FF instructs the printer to print the print data in a batch.
- (6) After printing, the printer returns to STANDARD MODE.

< Example 1 >

```
100 PRINT #1, CHR$(&H1B);"L";  
110 PRINT #1, CHR$(&H1B);"W"; CHR$(0); CHR$(0); CHR$(0); CHR$(0);  
120 PRINT #1, CHR$(200); CHR$(0); CHR$(144); CHR$(1);  
130 PRINT #1, CHR$(&H1B);"T"; CHR$(0);  
140 PRINT #1, "Page mode lesson Test1"  
150 PRINT #1, CHR$(&HC);
```

The program in Example 1 reserves a print area of 200 × 400 pitches extending from the start point (0, 0), and then prints the text "Page Mode lesson Test 1" on the first line of the print area as shown in Figure 4-3 "Example 1: Results of Print".

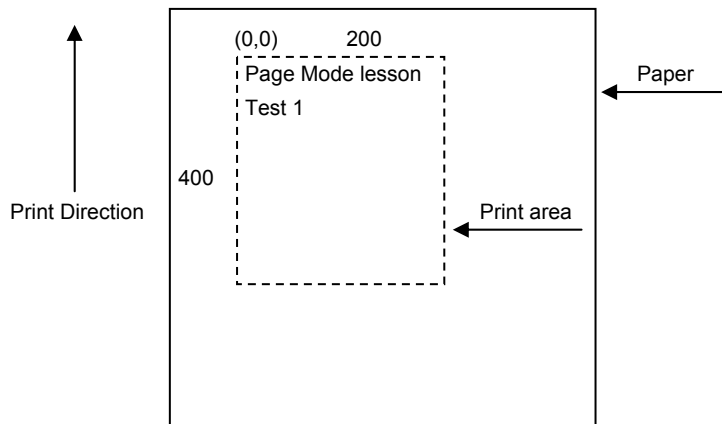

Figure 4-3 Example 1: Results of Print

In Figure 4-3, a line feed occurs between “lesson” and “Test 1” because the space “ ” next to “lesson” does not fit in the horizontal range of the 200 x 400-pitch print area. The line feed width conforms to the value specified by a command such as ESC 3.

It is possible to set as many print areas as desired before executing FF. If print areas overlap each other, the print area setup data are ORed with the previous data.

If you want to erase a section of mapped data, use the CAN command. The CAN command erases all data in the print area being specified. You can, therefore, use an ESC W to define a print area that encloses the section you want to erase, and then execute the CAN command, so that the section of the data is erased.

It is important to remember that any part of a character that overlaps with the specified print area will be erased.

< Example 2 >

```

100 PRINT #1, CHR$(&H1B);"L";
110 PRINT #1, CHR$(&H1B);"W"; CHR$(0); CHR$(0); CHR$(0); CHR$(0);
120 PRINT #1, CHR$(200); CHR$(0); CHR$(144); CHR$(1);
130 PRINT #1, CHR$(&H1B);"T"; CHR$(0);
140 PRINT #1, "Page mode lesson2CAN command";
150 PRINT #1, CHR$(&HA);
160 PRINT #1, "ABCDEFGHJKLMNOPQRST1234567890";
170 PRINT #1, CHR$(&HC);

```

First, an ESC L is sent to switch to PAGE MODE (100th line). Next, an ESC W is used to send eight arguments, n1 to n8, to reserve a print area. In this example, the arguments are sent in the sequence of 0, 0, 0, 0, 200, 0, 144, and 1, to reserve a print area that measures 200 from the start point (0, 0) in the “x” direction and 400 in the “y” direction (110th to 120th line). Furthermore, an ESC T is issued to specify the print direction to be “0” (130th line).

After the above setup, print data is sent (140th to 160th line). Finally, an FF is sent (170th line) to produce a print-out as shown in Figure 4-4 “Example 2: Result of Print”.

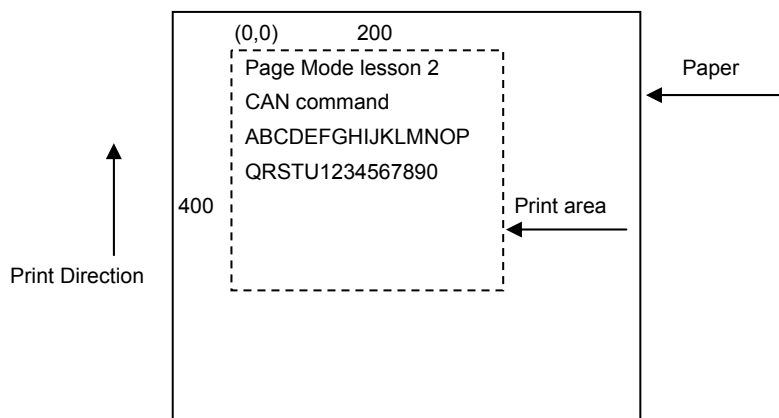

Figure 4-4 Example 2: Result of Print

Before an FF is sent (170th line), the following program code can be added to remove part of the data.

```
180 PRINT #1, CHR$(&H1B);"W";CHR$(72);CHR$(0);CHR$(120);CHR$(0);
190 PRINT #1, CHR$(36);CHR$(0);CHR$(48)CHR$(0);
200 PRINT #1, CHR$(&H18);
```

As a result of the additional program code, a print-out is executed as shown in Figure 4-5 "Print Result of Adding a Program of Example 3 to Example 2", where the string "GHI" is removed.

When strings are removed with CAN, the area where the string would have been is not used by the rest of the data, instead it is converted into a sequence of spaces.

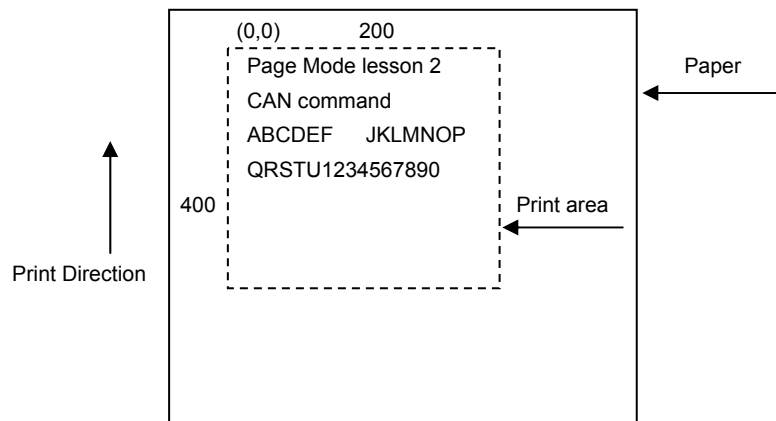

Figure 4-5 Print Result of Adding a Program of Example 3 to Example 2

4.2 Bidirectional Parallel Interface

Overview

The interface of the printer is a Level-1 compatible device according to IEEE-P1284. It supports the communication modes described in 4.2.1 below.

4.2.1 Parallel Interface Communication Mode

The parallel interface of the printer provides three communication modes as outlined below. When the printer is turned on or reset, it defaults to Compatibility mode.

- **Compatibility Mode**
Data is transmitted from the host to the printer in units of one byte. Usually, this mode is used for data transmission. You may switch to the other modes from Compatibility mode.
- **Nibble Mode**
Data is transmitted from the printer to the host in units of four bits. The data transmission from the printer uses a status signal line. To send one byte of data in this mode, two sets of four-bit data are sent consecutively.
- **Byte Mode**
Data is transmitted from the printer to the host in units of one byte. Data transmission from the printer uses an 8-bit data signal line. For Byte mode, the host must be capable of toggling the signal direction over the 8-bit data signal line. Communication from the host to the printer is called Forward mode, while communication from the printer to the host is called Reverse mode.

4.2.2 Interfacing Phases

Interfacing in each communication mode is divided into several phases. In addition, there is a phase for mode initialization, as well as a phase for mode switching. Interface signals may differ in name and function for different modes and different phases.

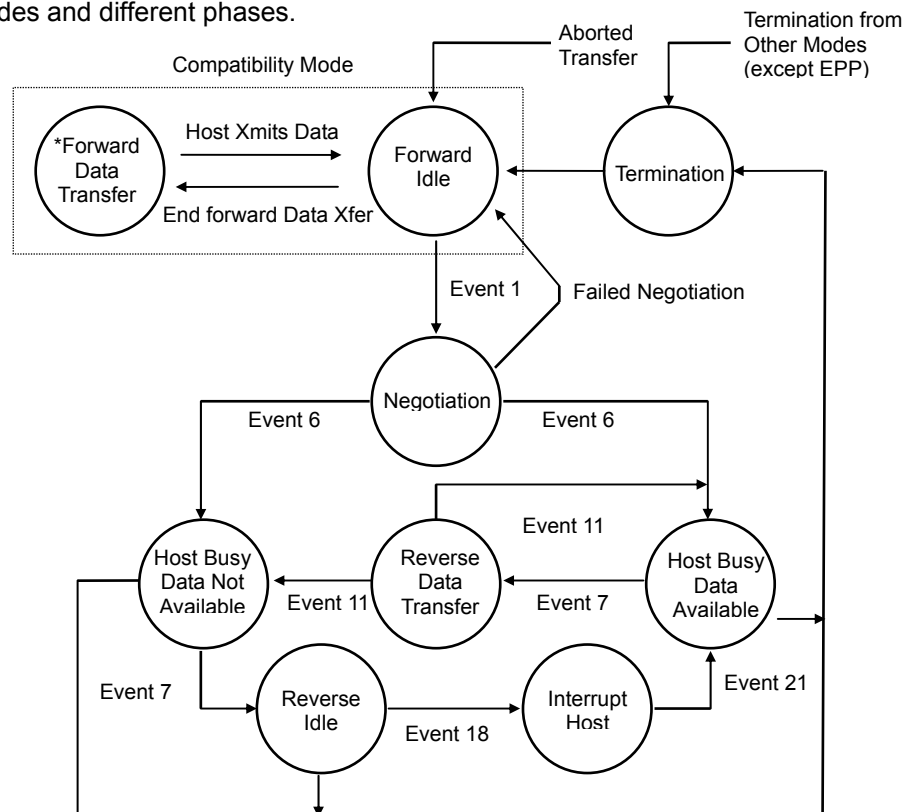

4.2.3 Negotiation

Overview

Usually, the printer is started in Compatibility mode, which corresponds to the Centronics interface phase. When the host intends to switch to the Nibble or Byte mode, it sends a request and negotiates with the printer. A general flow of negotiations is given below.

- (1) The host sets the IEEE 1284 Active signal to High. In response, the printer moves into the Negotiation phase.
- (2) The printer replies whether it can execute the mode requested by the host.
- (3) The interface terminates the Negotiation phase and moves into the communication phase.

Negotiation Procedure

The negotiations proceed as follows:

- (1) In IEEE 1284 communication mode, the host and printer are in Compatibility mode by default. They remain in Compatibility mode as long as the host recognizes the connected device as an IEEE 1284 compatible device.
- (2) To start negotiations, the host sets the communication mode request bit on the data path. (Event 0)
- (3) The host sets IEEE 1284 Active (nSelectIn) to High, and HostBusy (nAutoFd) to Low. (Event 1)
- (4) The printer responds by setting PtrClk (nAck) to Low, nDataAvail (nFault) to High, Xflag (Select) to High, and AckDatReq (PError) to High. (Event 2)
- (5) The host sets HostClk (nStrobe) to Low. In response, the printer latches the data of the communication mode request bit. (Event 3)
- (6) The host sets HostClk (nStrobe) and HostBusy (nAutoFd) to High. (Event 4)
- (7) If the printer has communication data to send to the host, it sets AckDataReq (PError) to Low, nDataAvail (nFault) to Low, and Xflag (Select) to the value corresponding to the communication mode. (Event 5)
Xflag: Nibble Mode : Low
Byte Mode : High
- (8) The printer sets PtrClk (nAck) to High to indicate that it is ready to read status lines. (Event 6)
- (9) If the printer has communication data to send to the host, the host moves into the Host Busy Available phase or Termination phase, and then returns to the Compatibility mode.
- (10) If the printer has no communication data to send to the host, the host moves into the Host Busy Data Not Available phase or Termination phase, and then returns to the Compatibility mode.
- (11) If the printer cannot support the communication mode requested by the host, it sets Xflag (Select) as follows:
When Nibble mode is requested : High
When Byte mode is requested : Low

Precautions

- (1) The Negotiation phase is triggered when the IEEE 1284 Active signal sent by the host becomes High.
- (2) In Compatibility mode, the time when the negotiation process begins is, as a general rule, after the host sets nStrobe to High and then the printer outputs an nAck pulse.

Once the nStrobe signal is set to High, however, the printer immediately moves into the Negotiation phase when the high state of IEEE 1284 Active is detected, even if the nAck pulse has yet to be output or is being output. In this case, if the printer has returned to Compatibility mode after Termination, no nAck pulse will be output.

- (3) Negotiations can be entered from the Busy or Error state of the Compatibility mode. In this case, the printer will not return to the Busy or Error state before the negotiations, but still remains in the printer state just after Termination.
- (4) If the host requested a communication mode that is not supported by the printer, it must move into the Termination phase and return to the Compatibility mode.

Table 2.4.1 Definitions of Request Bits in IEEE 1284 Communication Mode

Bit	Definition	Bit Values (76543210)	Hex. Code	Xflag	
				When Supported	In the Printer
7	Request Extensibility Link	10000000	80H	High	Low
6	Request EPP Mode	01000000	40H	High	Low
5	Request ECP Mode with RLE	00110000	30H	High	Low
4	Request ECP Mode	00010000	10H	High	Low
3	Reserved	00001000	08H	High	Low
2	Request Device ID: Return Data Using Nibble Mode Rev Channel Transfer	00000100	04H	High	High
	Byte Mode Rev Channel Transfer	00000101	05H	High	High
	ECP Mode Transfer without RLE	00010100	14H	High	Low
	ECP Mode Transfer with RLE	00110100	34H	High	Low
1	Reserved	00000010	02H	High	Low
0	Byte Mode Reverse Channel Transfer	00000001	01H	High	High
None	Nibble Mode Reverse Channel Transfer	00000000	00H	Low	Low
	Illegal or Contradictory Request	Other than above	Other than above	—	Low

The printer only supports the Nibble and Byte modes. For a request for any other mode, Xflag is set to Low.

Data Communication from Printer to Host

Nibble Mode

In this mode, data is transferred between the printer and the host through the procedure described below. The steps beginning from (1) are applicable when the Negotiation phase has switched to the Host Busy Data Available phase. If the Negotiation phase has switched to the Host Busy Data Not Available phase, the procedure starts at step (9).

- (1) After the negotiations for the entry into Nibble mode are completed, the host sets HostBusy (nAutoFd) to Low to indicate that it is ready to receive data from the printer. (Event 7)
- (2) The printer places the low-order four bits on the reverse channel data line and sets PtrClk (nAck) to Low. (Events 8 and 9)
- (3) The host sets HostBusy (nAutoFd) to High to indicate that it has latched data and received the signal in Event 9. (Event 10)
- (4) The printer sets PtrClk (nAck) to High. This completes transfer of the first nibble. (Event 11)
- (5) Steps (1) to (3) are repeated to transfer the high-order four bits, before proceeding to steps (6) and on.
- (6) After the host has set HostBusy (nAutoFd) to High (Event 10) and received data, the printer must set the four status lines as shown below. (Event 13)
 - PtrBusy (Busy) : Returned to the status given in Forward mode.
 - nDataAvail (nFault) : Set to Low if there is data to be sent.
 - AckDataReq (PError) : Set to Low if there is data to be sent.
 - Xflag (Select) : Set to the current mode (i.e., set to Low).
- (7) The printer sets PtrClk (nAck) to High. (Event 11)
- (8) After Event 11, the host checks the signals set by the printer in Event 13. With this check the host determines:
 1. Whether there is more data to be sent from the printer to the host;
 2. And whether data can be transferred from the host to the printer.
- (9) If there is no more data to be sent from the printer after the transfer of one byte (two nibbles), the host chooses one of three status selections:
 1. Performing Termination and returning to the Compatibility mode.
 2. Remaining in the Host Busy Data Not Available phase.
 3. Setting HostBusy (nAutoFd) to Low (Event 7) and moving to the Reverse Idle phase.
- (10) If there is more data to be received from the printer, the host chooses one of three status selections:
 1. Setting HostBusy (nAutoFd) to Low and indicating that the host is ready to receive.
 2. Remaining in the Host Busy Data Available phase.
 3. Performing Termination and returning to the Compatibility mode.
- (11) If the host selected the Host Busy Data Available phase and set HostBusy (nAutoFd) to Low, the printer repeats the steps from (2) onwards.
- (12) If the host selected the Reverse Idle phase and new data becomes available to be sent from the printer, the printer sets PtrClk to Low to request the host for an interrupt. (Event 18)
- (13) The printer sets PtrClk back to High. (Event 19)
- (14) Upon receiving a request for interrupt from the printer, the host responds by setting HostBusy (nAutoFd) to High. (Event 20)
- (15) Finally, the printer responds to the host by setting AckDataReq (PError) to Low, and then the host moves to the Host Busy Data Available phase. (Event 21)

Byte Mode

In this mode, data is transferred between the printer and the host through the procedure described below. The steps beginning from (1) are applicable when the Negotiation phase has switched to the Host Busy Data Available phase. If the Negotiation phase has switched to the Host Busy Data Not Available phase, the procedure starts at step (9).

- (1) After the negotiations for the entry into the Byte mode are complete, the host indicates that it is ready to receive data from the printer. This is indicated by switching the data bus to a high-impedance state and setting HostBusy (nAutoFd) to Low. (Events 14 and 7)
- (2) The printer places communication data on the data bus. (Event 15)
- (3) The printer sets PtrClk (nAck) to Low. (Event 9)
- (4) The host sets HostBusy (nAutoFd) to High to indicate that it has latched data and received the signal in Event 9. (Event 10)
- (5) The printer must set the four status lines as shown below. (Event 13)
 - PtrBusy (Busy): Returned to the status given in the Forward mode.
 - nDataAvail (nFault): Set to Low if there is data to be sent.
 - AckDataReq (PError): Set to Low if there is data to be sent.
 - Xflag (Select): Set to the status given during the last negotiation (i.e., set to Low).
- (6) The printer sets PtrClk (nAck) to High (Event 10) and ends the Byte handshake. (Event 11)
- (7) The host indicates that it has succeeded in receiving the data. This is indicated by setting HostClk (nStrobe) to Low (Event 16) and then to High. (Event 17)
- (8) Events 10 and 16 may occur simultaneously, and Events 7 and 17 may occur simultaneously. (Such as when HostBusy and HostClk are used together.)
- (9) After transferring one byte of data, the printer signals to the host whether it has more data to transfer. When there is no more data to be received by the host from the printer, the host chooses one of three status selections:
 1. Performing Termination and returning to the Compatibility mode.
 2. Remaining in the Host Busy Data Not Available phase.
 3. Setting HostBusy (nAutoFd) to Low and moving to the Reverse Idle phase. (Event 7)
- (10) When more data is to be received from the printer, the host chooses one of three status selections:
 1. Setting HostBusy (nAutoFd) to Low and indicating that the host is ready to receive.
 2. Remaining in the Host Busy Data Available phase.
 3. Performing Termination and returning to the Compatibility mode.

Device ID

The device ID is a character string that provides the ID, the type, and other information regarding the printer connected to the interface. When the printer receives a request for a device ID from the host, it replies with the following device ID:

```
<00>H<2E>H
MFG : CITIZEN;
CMD : ESC/POS;
MDL : BD2-2220;
CLS : PRINTER;
```

The first two bytes of the device ID indicate the length of the entire device ID. For a description of a request for a device ID, refer to the “Negotiation” section.

When the host receives the device ID string of the length indicated by the first two bytes, it must do so consecutively, without terminating the process until the entire device ID is received. If the process is terminated halfway, the printer discards the rest of the string; when the printer receives a new request for the device ID, it sends the device ID beginning from the first character of the ID. After receiving the ID of the length indicated by the first two bytes, the host must carry out the termination even if the printer has data to send (Data Available). If the host does not carry out Termination and tries to receive data, the printer sends the printer status.

Termination

Termination is the process of returning to Compatibility mode from the Nibble or Byte modes. When performing Termination, the host sets the signals as follows:

- IEEE 1284 Active (nSelectIn): Low
- HostBusy (nAutoFd): High (Event 22)

There are two methods of Termination:

- (1) Termination through a handshake between the host and the printer
- (2) Immediate termination

(1) Termination through a handshake between the host and the printer:

When switching from Reverse mode to Compatibility mode, this termination method can be used if the interface is activated (IEEE 1284 Active: High) and Event 22 has taken place.

- 1) The printer responds to IEEE 1284 Active by setting PtrBusy (Busy) and nDataAvail (nFault) to High. (Event 23)
- 2) The printer then inverts Xflag (Select) and sets PtrClk (nAck) to Low. (Event 24)
- 3) The host sets HostBusy (nAutoFd) to Low. (Event 25)
- 4) The printer returns nDataAvail (nFault), Xflag (Select), and AckDataReq (PError) to the status given in the Compatibility mode, and sets PtrClk (nAck) to High. (Events 26 and 27)
- 5) The host sets HostBusy (nAutoFd) to High to terminate the handshake and return the interface to the Compatibility Mode Idle phase. (Event 28)
- 6) The printer changes PtrBusy (Busy) to be able to receive data from the host.

(2) Immediate termination:

- 1) If the interface is deactivated (IEEE 1284 Active: Low) without Event 22 having taken place, the printer immediately performs Termination. In this termination, the data is not guaranteed, and the printer switches the data bus from output to input within 1 µsec.

In the Reverse Idle phase, the printer can notify the host that it has data to transfer to the host. The notification may occur simultaneously with termination in order for the host to move from the Idle phase to the Compatibility mode.

If the printer has data to send, it initiates the Interrupt phase indicated by Events 8 and 9. In this case, if 1284 - Active (nSelectIn) was set to Low before HostBusy (nAutoFd) changed from High to Low, the printer interprets that the host has switched to the Termination phase, and then completes the normal termination through handshaking.

4.3 Identification of Send Status

Because the status sent from the printer has certain fixed bits, it is possible to identify to which command the status belongs.

When using ASB (Automatic Status Back), however, the first byte of ASB should be checked, and then the three consecutive bytes except for XOFF should be treated as ASB data.

Identification of Send Status

Command and Function	Status
GS l	<0**0****>B
GS r	<0**0****>B
XON	<00010001>B
XOFF	<00010011>B
DLE EOT	<0**1**10>B
ASB (1st byte)	<0**1**00>B
ASB (2nd - 4th bytes)	<0**0****>B

4.4 Memory Switch

Memory switch has a function to store various settings selected by the user alternatively in nonvolatile memory. Memory switch setting is retained unless the memory switch is changed.

Memory switch setting can be changed by the manual setting in memory switch change mode or by a command.

* Hereinafter memory switch is referred to as MSW.

4.4.1 Memory Switches

No.	Function	OFF	ON
MSW1-1	Power ON Info	Send	Not send
MSW1-2	Buffer Size	4K bytes	45 bytes
MSW1-3	Busy Condition	Full/Err	Full
MSW1-4	Receive Error	Print " ? "	Invalid
MSW1-5	CR Mode	Ignored	LF
MSW1-6	Reserved	Fixed	-
MSW1-7	DSR Signal	Invalid	Valid
MSW1-8	Reserved	Fixed	-
MSW2-1	Reserved	-	Fixed
MSW2-2	Reserved	-	Fixed
MSW2-3	Spool print	Invalid	Valid
MSW2-4	Full col print	Line Feed	Wait Data
MSW2-5	Resume aft PE	Print next line	Print top
MSW2-6	Reserved	-	Fixed
MSW2-7	Reserved	Fixed	-
MSW2-8	Reserveed	Fixed	-
MSW3-1	Resum Ctrr Err	Valid	Invalid
MSW3-2	Reserved	Fixed	-
MSW3-3	Reset signal	Valid	Invalid
MSW3-4	Reserved	Fixed	-
MSW3-5	Reserved	Fixed	-
MSW3-6	Reserved	Fixed	-
MSW3-7	Reserved	Fixed	-
MSW3-8	Resume Head-up Err	Close	Command

Default (Factory shipment)

4.4.2 Details of Memory Switches

Functions of memory switches, operations at ON (1) setting, and operation at OFF (0) setting are described below.

Memory switches without function setting are not explained but default must not be changed.

When setting memory switches manually, ON setting allows POWER LED to light and OFF setting allows it to go off.

(1) MSW1

- MSW 1-1: Power ON Information Send/Not send

[Outline]

At power ON, the printer can send 3-byte Power ON Info status data (<3B>H <31>H <00>H) to the computer to inform the host that the Printer Power is turned ON.

This switch sets Send/Not send of Power ON Information.

	OFF (0)	ON (1)
Power ON Info	Send	Not send

Operation at ON (1):

Power ON Info function is disabled and no status is sent to the computer.

Operation at OFF (0):

Power ON Info function is valid and status is sent to the computer.

[Default] OFF(0) [Not send]

- MSW 1-2: Capacity of input buffer (Receive buffer)

[Outline]

Selects the size of input buffer.

	OFF (0)	ON (1)
Buffer Size	4K bytes	45 bytes

Operation at ON (1):

Sets input buffer size to 45 bytes.

Receive buffer is full and the printer is set in the BUSY state during the period from the time the idle space decreases to 16 bytes till it increases to 26 bytes.

Operation at OFF (0):

Sets input buffer size to 4K bytes.

Receive buffer is full and the printer is in the BUSY state during the period from the time the idle space decreases to 128 bytes till it increases to 256 bytes.

[Default] OFF(0) [4k bytes]

·MSW 1-3: BUSY Condition

[Outline]

Selects the condition for the printer to become BUSY state. Auto status sending function is also activated.

	OFF (0)	ON (1)
Busy Condition	Full/Err	Full

Operation at ON (1):

When receive buffer is full, the printer is in the BUSY state.
Auto status sending (ASB) function is valid.

Operation at OFF (0):

When receive buffer is full or in the offline state, the printer is in the BUSY state.
Auto status sending (ASB) function is invalid.

Supplementary explanation:

Even when ON is selected, the printer is in the BUSY state at Power ON, at the use of Reset through I/F, and at self-printing.

	Printer Status	MSW1-3 OFF	MSW1-3 ON
Offline	At Power ON, at the use of Reset through I/F		
	During self printing		
	At cover open		—
	During paper feed by FEED SW		—
	At Paper End (Including Print Stop with PNE)		—
	At the occurrence of error		—
	At the Standby state during macro execution by FEED SW		—
Buffer full	At receive buffer full		

[Default] OFF(0) [Full/Err]

·MSW 1-4: Data Processing at the occurrence of receive error

[Outline]

Printer with serial interface detects Framing error, Overrun error, and Parity error of received data.
This switch selects whether to print “ ? ” for data with error detected.

	OFF (0)	ON (1)
Receive Error	Print “ ? ”	Invalid

Operation at ON (1): Does not print “?”.

Operation at OFF (0): Prints “?”.

[Default] OFF(0) [Print “ ? ”]

·MSW 1-5: CR Code Processing

[Outline]

Selects whether the printer operates in the same manner as LF (<0A>H) when it receives the CR (<0D>H) code.

	OFF (0)	ON (1)
CR mode	Ignored	LF

Operation at ON (1):

Operates in the same manner as LF when receiving CR code.

Prints data in the print buffer and performs line feed in accordance with the amount of preset line feed.

Operation at OFF (0):

Even when the printer receives a CR code, it ignores CR code and causes no operation.

[Default] OFF(0) [Ignored]

·MSW1-6: Reserved (OFF(0)Fixed)

·MSW 1-7: Reset Valid/Invalid by DSR (Serial I/F 6 Pin)

[Outline]

Selects whether to reset the printer by the signal of DSR (Serial interface 6 Pin).

	OFF (0)	ON (1)
DSR Signal	Invalid	Valid

Operation at ON (1): Used as Reset signal.

Operation at OFF (0): Not used as Reset signal.

[Default] OFF(0) [Invalid]

·MSW 1-8: Reserved (OFF(0)Fixed)

(2) MSW2

- MSW 2-1: Reserved (ON(1)Fixed)
- MSW 2-2: Reserved (ON(1)Fixed)

- MSW 2-3: Valid/Invalid of buffered printing

[Outline]

Selects Valid/Invalid of buffered printing.

	OFF (0)	ON (1)
Spool print	Invalid	Valid

Operation at ON (1):

Enables buffered printing.

Stores a certain amount of print buffer in the internal RAM and prints it at a time.

Operation at OFF (0):

Disables buffered printing.

[Default] ON(1) [Valid]

- MSW2-4: Full-column printing

[Outline]

Selects the processing used when print data is at the end of a line or at the right-end of print width.

	OFF (0)	ON (1)
Full col printing	Line Feed	Wait Data

Operation at ON (1):

When the printer receives data/command exceeding full-column width, it waits for print data. If the data exceeding the full-column width is a command, the printer operates in accordance with the command.

Operation at OFF (0):

When the printer receives data/command exceeding full-column width, it automatically prints the data in the buffer and feeds a line.

<Example>

If the first data exceeding full-column width is <LF>, the printer feeds 2 lines with OFF (0) and feeds 1 line with ON (1).

[Default] OFF(0) [Line Feed]

- MSW 2-5: Processing after Cover Close and PE Clear

[Outline]

Selects the processing to be carried out when resuming printing after the printer cover is opened or paper empty (PE) is detected during printing.

	OFF (0)	ON (1)
Resume aft PE	Print next line	Print top

Operation at ON (1):

Resumes printing at the top of remaining data in printer.

When the printer cover is opened or PE is detected during printing of image, barcode, double-height character, or page mode and after recovery, the printer resumes printing from the top of the remaining print data.

Operation at OFF (0):

Prints from the succeeding data.

When the printer cover is opened or PE is detected during printing and after recovery, the printer resumes printing from the next position following the error.

[Default] OFF(0) [Print next line]

- MSW 2-6: Reserved (ON(1)Fixed)
- MSW 2-7: Reserved (OFF(0)Fixed)
- MSW 2-8: Reserved (OFF(0))

(3) MSW3

- MSW 3-1: Reserved (OFF(0)Fixed)

[Outline]

Select return method from cutter lock error.

	OFF (0)	ON (1)
Resum Cctr Err	Valid	Invalid

Operation at ON (1):

OPERATION: Return by command.

After removing error cause, return with command <DLE ENQ n>.

Operation at OFF (0):

Return with FEED switch.

After removing error cause, return by long pressing FEED SW (1 sec or longer).

[Default]OFF (0) [Valid]

- MSW 3-2: Reserved (OFF(0)Fixed)

- MSW 3-3: Reset signal

[Outline]

Selects whether to reset the printer by the signal of parallel I/F 31 Pin.

	OFF (0)	ON (1)
Reset signal	Valid	Invalid

Operation at ON (1): Used as Reset signal.

Operation at OFF (0): Not used as Reset signal.

[Default] OFF(0) [Valid]

- MSW 3-4: Reserved (OFF(0)Fixed)
- MSW 3-5: Reserved (OFF(0)Fixed)
- MSW 3-6: Reserved (OFF(0)Fixed)
- MSW 3-7: Reserved (OFF(0)Fixed)

- MSW 3-8: Clearing Head-Up Error

[Outline]

Selects the method of clearing Head-Up error.

	OFF (0)	ON (1)
Resume Open Err	Close	Command

Operation at ON (1):

Printer clears error when it receives a command <DLE+ENQ+n> after detecting head-down.

Operation at OFF (0):

Printer automatically clears error when it detects head-down.

[Default] OFF(0) [Close]